

# Electromechanical and solid-state Zelio<sup>®</sup> Relays

Catalog  
2010





# Reduce the size of your enclosures and, at the same time, increase machine reliability...



with these new Zelio® Relays

## > Electromechanical relays RSL

Only 6 mm wide, thus saving considerable space in your enclosures



6 mm wide

## > Solid-state relays SSR

Enhanced service life provided by electronic technology



Enhanced service life

## Contents

### Introduction

Save Space with Zelio Relay RSL .....	4-5
Choose long life and silent operation with Zelio Relay SSR .....	6-7
Electromechanical and solid-state relays panorama .....	8-9

### Technical characteristics

Zelio Relay RSL .....	12-17
Zelio Relay RSB, RXM, RUM, RPM .....	18-49
Zelio Relay ABR, ABS .....	54-73
Zelio Relay SSR .....	74-81

Make the most of your energy<sup>SM</sup>



# Save space with Zelio<sup>®</sup> Relay RSL

## Only 6 mm wide

reduces the size of your enclosure

## > A solution for any application

### A versatile offer

- > An offer with maximum flexibility, comprising:
  - complete products: a single reference for a relay mounted on a socket,
- > Wide choice of sockets available covering a range of voltages from 12 to 230 V.
  - select the relay and associated socket according to your application.

### An offer that meets the most demanding standards

- Conformity with the European RoHS (Restriction of Hazardous Substances) directive.
- Conformity to international standards IEC/EN 61810-1, UL508, CSA C22.2 N°14, GOST.



## 100% RoHS

Schneider Electric commits itself to reducing the environmental impact of its products

## > Increased reliability in operation

### Added protection in the socket

Built-in protection from transients and reverse polarity voltages.

### LED indicator

Power on and relay status indication.



### Standard 1 C/O relays

For general purpose load requirements.

Up to **6A** switching

## > Simple installation and maintenance

Simple maintenance of relay in socket  
Using locking/unlocking lever.

### Simple wiring

Bus jumpers available as accessories.

### Simple mounting on DIN rail

### 2 connection choices

Suitable for the majority of your applications.



Screw connector



Spring terminal

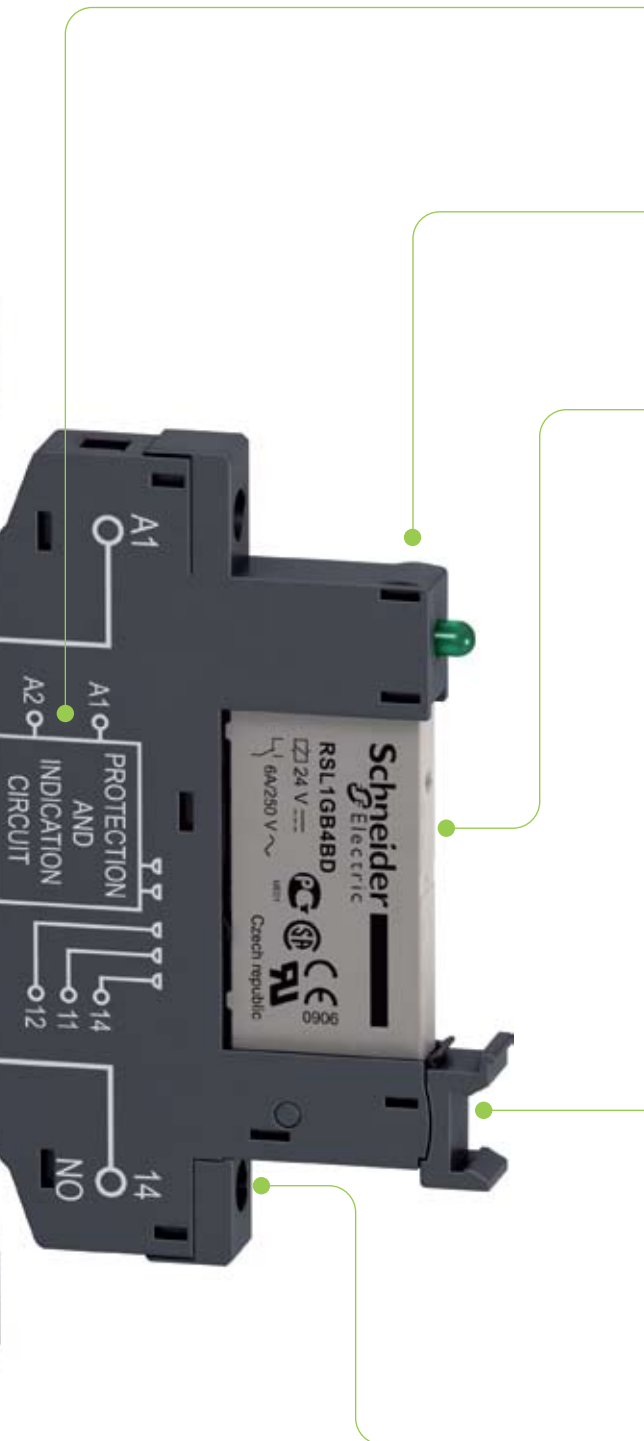

# Choose long life and silent operation with Zelio® SSR Relays

## > Optimized heat exchange

The new solid-state relays SSR with SCR (Semiconductor Controlled Rectifier) outputs offer you two alternatives:

### SSRD range

Integrated heat sink to provide factory tested heat exchange, that easily mounts by clipping directly onto DIN rail. Can also be panel mounted.

### SSRP range

Panel mounted, either by itself or combined with a heat sink for applications requiring considerable heat exchange.

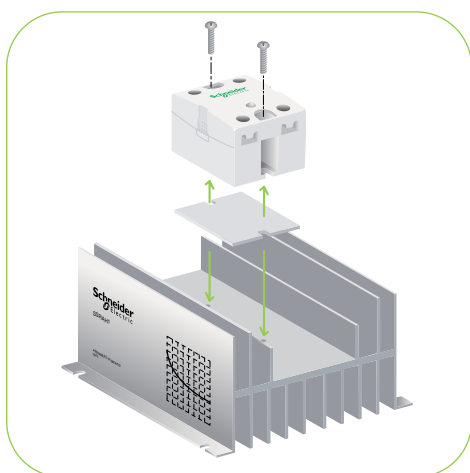

SSRP relay mounted on heat sink with thermal transfer pad



## > Distinctive indication

A green LED on the front face of the products provides instant indication of the presence of input voltage.

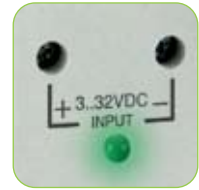

## > High performance

### High breaking capacities

- From 10 to 125 A for relays SSRP
- From 10 to 45 A for relays SSRD

### Wide supply voltage range

- From 3 to 32 VDC and 90 to 280 VAC

### Outputs suited to applications

- From 24 to 280 VAC and 48 to 530/660 VAC

### Space Saving SSRD series

- Only 22.5 mm and up to 45.5 mm wide

### Enhanced service life

- Reduced preventive maintenance. SSR relays have little to no maintenance required once applied correctly.

### Silence of electronic technology

- Complete silence when switching

### Vibration resistant

- Even in the event of excessive vibration, the relay will not change state

### Enhanced service life

due to electronic relay technology

### Complete silence when switching

providing suitability for building and hospital applications

### High switching frequency

particularly on packaging and textile machines

## > Conformity to international standards

**100%  
RoHS**

Schneider Electric commits itself to reducing the environmental impact of its products

# Panorama Zelio® Relays

## Electromechanical relays



Contact configuration	1 C/O	1 or 2 C/O	1 or 2 C/O	2, 3 or 4 C/O
Current	6 A	8-12-16 A	5-12 A	6-10-12 A
Mounting	DIN rail		DIN rail	DIN rail or panel
Catalog numbers	<b>RSL</b>	<b>RSB</b>	<b>ABR</b>	<b>RXM</b>
Pages	12 to 17	20 to 23	54 to 73	24 to 31

### Electromechanical relay advantages

- Wide number of contacts (up to 4)
- Easy installation and maintenance
- Socket compatible plug in relays
- Flag indicator to show contact status
- Lockable test button for checking circuit during build
- Magnetically isolated
- Coil voltage LED indicator



## Electromechanical relays



2, 3 or 4 C/O	1, 2, 3 or 4 C/O	2 C/O or 2 N/O
---------------	------------------	----------------

10 A	15 A	30 A
------	------	------

DIN rail or panel		
-------------------	--	--

<b>RUM</b>	<b>RPM</b>	<b>RPF</b>
------------	------------	------------

32 to 41	42 to 49	50 to 53
----------	----------	----------

## Solid-state relays



1 N/O	1 N/O	1 N/O
-------	-------	-------

3 A	10 ...45 A	10 ...125 A
-----	------------	-------------

DIN rail	DIN rail or panel	Panel
----------	-------------------	-------

<b>ABS</b>	<b>SSRD</b>	<b>SSRP</b>
------------	-------------	-------------

54 to 73	74 to 81	74 to 81
----------	----------	----------

### Solid-state relay (SSR) advantages

- Enhanced service life
- Wide supply voltage range and high breaking current (up to 125 A), suited to packaging and textile machines
- Input power indicator
- Completely silent switching, suitable for building and hospital applications
- Vibration resistant

Relays			
Contact types			
Circuit symbol	Contact configuration	EU nomenclature	USA nomenclature
	Make contact (Normally Open)	N/O	SPST-NO DPST-NO nPST-NO (1)
	Break contact (Normally Closed)	N/C	SPST-NC DPST-NC nPST-NC (1)
	Changeover Contact	C/O	SPDT DPDT nPDT (1)

Utilization categories		
Category	Type of current	Applications
AC-1	~ single-phase ~ 3-phase	Resistive or slightly inductive loads.
AC-3	~ 3-phase	Starting and braking of squirrel cage motors; reversing direction of rotation only after stopping of motor.
AC-4	~ 3-phase	Starting of squirrel cage motors, inching. Plugging, reversing direction of rotation.
DC-1	---	Resistive or slightly inductive loads (2).
AC-14	~ single-phase	Control of electromagnetic loads (< 72 VA), auxiliary control relays, power contactors, electromagnetic solenoid valves and electromagnets.
AC-15	~ single-phase	Control of electromagnetic loads (> 72 VA), auxiliary control relays, power contactors, electromagnetic solenoid valves and electromagnets.
DC-13	---	Control of electromagnetic loads, auxiliary control relays, power contactors, magnetic solenoid valves and electromagnets.

Protection categories		
Category	Explanation	Condition
RT 0	Unenclosed relay	Relay not provided with a protective case.
RT I	Dust protected relay	Relay provided with a case which protects its mechanism from dust.
RT II	Flux-proof relay	Relay capable of being automatically soldered without allowing the migration of solder fluxes beyond the intended areas.
RT III	Wash-tight relay	Relay capable of being automatically soldered and then washed to remove flux residues without risk of ingress of flux or washing solvents.
RT IV	Sealed relay	Relay provided with a case which has no venting to the outside atmosphere.
RT V	Hermetically sealed relay	Sealed relay having an enhanced level of sealing.

(1) n = number of contacts.

(2) The switchable voltage can be doubled, for an equal current, by connecting two contacts in series.

## Protection modules

Whenever an inductive load is de-energized (coil of a relay or of a contactor), an overvoltage appears at its terminals. This voltage peak can reach several thousand volts and a frequency of several MHz.

It is likely to disturb the operation of automation systems which contain electronic devices.

Protection modules are used to reduce the voltage peak on de-energization and they therefore limit the energy of interference signals to a level that will not disturb surrounding coils and electronic devices.

These modules are used to avoid:

- electromagnetic compatibility problems
- the deterioration of contact materials
- the destruction of insulation due to overvoltage
- the destruction of electronic components

## Diode protection module (with or without LED)

### Advantages

- accumulation of energy allowing current flow in the same direction
- absence of any voltage peaks at the coil terminals
- low cost

### Considerations

- increase in relay drop-out time (up to 3 to 4 times the usual time)
- no polarity protection
- de-energization of the relay

## Protection module with varistor

### Advantages

- can be used with  $\sim$  and  $\text{---}$  supply
- voltage peak limited to about  $2 U_n$
- little effect on relay drop-out time

### Considerations

- no modification of coil's own oscillating frequency
- limitation of switching frequency

## Protection module with RC circuit

### Advantages

- coil oscillating frequency reduced to about 150 Hz
- voltage peak limited to  $3 U_n$
- little effect on relay drop-out time

### Considerations

- no protection for low voltages

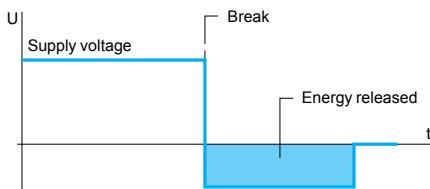

Coil voltage with diode protection module ( $\text{---}$  only)

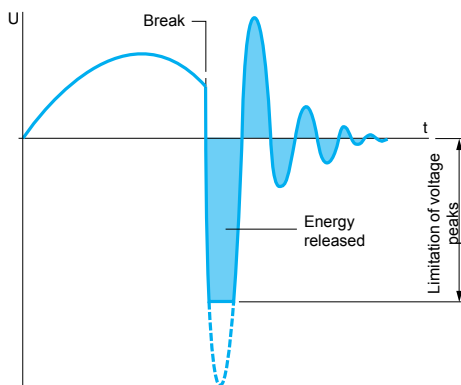

Coil voltage with varistor protection module ( $\sim$  and  $\text{---}$ )

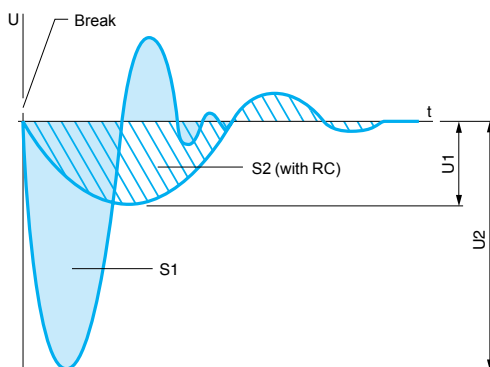

Coil voltage with RC circuit protection module ( $\sim$  only)

S1 = S2 = Energy released

### Introduction

RSL slim interface relays offers compact size in a modular design: their slim width (6 mm) saves valuable space when mounting on a DIN rail at the back of an enclosure.

RSL relays are available in two versions:

■ **Pre-assembled range:** a single catalog number for a standard relay mounted on a socket.

- The socket includes a built-in protection circuit (against transients and reverse polarity voltages) and an LED indicator as standard.
- Wire connection options: screw connectors and spring terminals.
- This pre-assembled solution covers a wide range of operating voltages from 12 to 230 V.

■ **Individual relays and sockets:**

- The relay and the socket can be provided separately according to the requirements of the application.
- Simple maintenance: an RSL slim relay can be replaced without any need to disconnect the socket wiring.

### Description

#### RSL slim interface relays, pre-assembled

- 1 6 A standard relay with 1 C/O contact.
- 2 Retention lever for easy removal of the relay from its socket.
- 3 Sockets: wire connection by screw connector or spring terminals.
- 4 All sockets have a built-in protection circuit and an LED indicator.



#### RSL slim interface relay

- 1 Five flat, reinforced PCB pins.



#### Sockets for RSL slim interface relays

- 1 Five female contacts for the relay pins.
- 2 Retention lever which accepts optional ID tags.
- 3 Wire connection by screw connector or spring terminals.
- 4 Built-in protection circuit and LED indicator.
- 5 Locating slot for mounting on DIN rail.

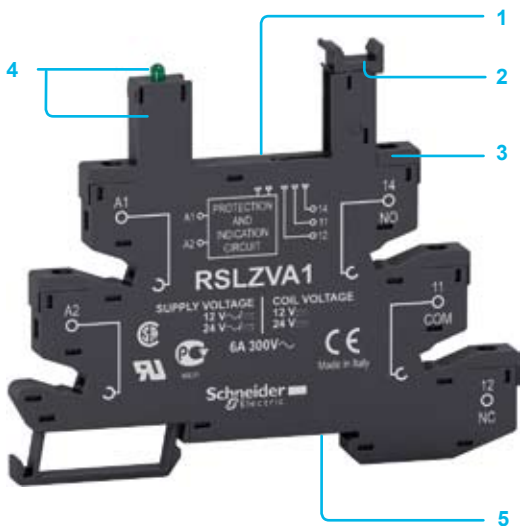

General characteristics			
<b>Conforming to standards</b>			IEC 61810-1, UL 508, CSA C22-2 No. 14
<b>Product certifications</b>			UL E173076, UL E172326, CSA 240278, CSA 247510, GOST
<b>Ambient air temperature</b> around the device	Storage	°C	- 40... + 85
	Operation	°C	- 40... + 55
<b>Vibration resistance</b> conforming to IEC/EN 60068-2-6	In operation		10 gn
	Not operating		5 gn
<b>Degree of protection</b>	Conforming to IEC/EN 60529		IP 40 (Relays) IP 20 (Sockets)
	<b>Shock resistance</b> conforming to IEC/EN 60068-2-27	Opening	10 gn
Closing		5 gn	
<b>Protection category</b>			RT III
<b>Mounting position</b>			Any
Insulation characteristics			
<b>Rated insulation voltage (U<sub>i</sub>)</b>		V	250 (IEC)
<b>Rated impulse withstand voltage (U<sub>imp</sub>)</b>		kV	6
<b>Dielectric strength</b> (rms voltage)	Between coil and contact	~ V	4000
	Between contacts	~ V	1000

Contact characteristics				
Relay type			RSL1AB●●●	
Number and type of contacts			1 C/O standard	
Contact materials			AgSnO2	
Conventional thermal current (I <sub>th</sub> )	For ambient temperature ≤ 55 °C	A	6	
Rated operational current in utilization categories AC-1 and DC-1	Conforming to IEC	N/C	A 6	
		N/O	A 6	
	Conforming to UL	A	6	
Switching current	Minimum	mA	100	
Switching voltage	Rated	~ V	250	
	Maximum	V	~ 400, --- 300	
	Minimum	V	12	
Nominal load (resistive)		A / ~ V	6 / 250 V (at 50mW)	
Switching capacity	Maximum	~	VA	1500
		---	W	18...150 (depending on the voltage)
	Minimum		mW	120
Maximum operating rate In operating cycles / hour	No-load		72 000	
	Under load		360	
Mechanical durability	In millions of operating cycles		≥ 10	
Electrical durability In millions of operating cycles	Resistive load		See curves below	
	Inductive load		0.05 (N/O contact: ~250 V, 3 A, AC-15)	

Maximum switching capacity on --- load

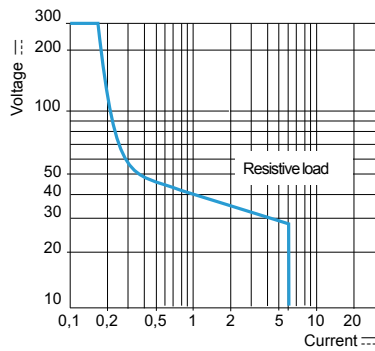

Coil characteristics						
Average consumption		---	W	0.17		
Drop-out voltage threshold		---		≥ 0.05 U <sub>c</sub>		
Operating time (response time)	Between coil energization and making of the NO contact	---	ms	12 max		
	Between coil de-energization and making of the NC contact	---	ms	5 max		
Control circuit voltage U <sub>c</sub>		V	12	24	48	60
Relay control voltage codes			JD	BD	ED	ND
DC supply	Average resistance at 23 °C ± 10%	Ω	848	3390	10 600	20 500
	Operating voltage limits	Min.	V	8.4	16.8	33.6
Max.		V	16.8	33.6	67.2	84

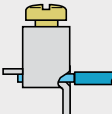
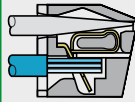
Socket characteristics			
Socket type		RSLZV●●	RSLZR●●
Relay types used		RSL1●●●●	RSL1●●●●
Conforming to standards		IEC 61984, UL 508, CSA C22-2 No. 14	
Product certifications		UL, CSA, GOST	
Contact terminal arrangement		Separate	Separate
Wire connection method		Screw connector	Spring terminals
Width	mm	6.2	6.2
Electrical characteristics			
Conventional thermal current (I <sub>th</sub> )	A	6	
Maximum operating voltage	~ V	300	
Insulation characteristics			
Between adjacent output contacts	V <sub>rms</sub>	2500	
Between input and output contacts	V <sub>rms</sub>	2500	
Between contacts and DIN rail	V <sub>rms</sub>	2500	
General characteristics			
Ambient air temperature around the device	Operation	°C	-40...+70 (-40 to +55 for U > 80 V)
	Storage	°C	-40...+85
Degree of protection	Conforming to IEC/EN 60529		IP 20
Connection	Solid wire without 1 conductor cable end	mm <sup>2</sup>	0.2...2.5
		AWG	24...14
	Flexible wire 1 conductor with cable end	mm <sup>2</sup>	0.2...2.5
		AWG	24...14
Screw size	mm	M 2.5	
Maximum tightening torque	Nm	0.5	10 N...40 N (0.2 ... 1.5 mm <sup>2</sup> )
Mounting		On 35 mm DIN rail	
Mounting on DIN rail		By plastic compression spring	
Terminal reference		IEC	
LED indicator		Yes (built-in)	
Added protection in circuit		Yes (built-in)	
Wire connection method		Screw connector	Spring terminal
			

Sockets operating voltage				
		Operating voltage	Tolerance	Control circuit voltage (relay)
		V		V
Socket type	RSLZVA1, RSLZRA1	~ / ~ 12	+ 20% / - 5%	~ 12
		~ / ~ 24	+ 20% / - 10%	~ 24
	RSLZVA2, RSLZRA2	~ / ~ 48	+ 20% / - 10%	~ 48
		~ / ~ 60	+ 20% / - 10%	~ 60
	RSLZVA3, RSLZRA3	~ / ~ 110	+ 15% / - 20%	~ 60
	RSLZVA4, RSLZRA4	~ / ~ 230	+ 15% / - 20%	~ 60



RSL 1PV●● RSL 1PR●●

### Slim interface relays, pre-assembled

Standard relays mounted on socket equipped with LED and protection circuit

Sold in lots of 10

1 C/O contact - Thermal current (Ith) 6A

Operating voltage (input voltage)	Socket type		Spring terminal		Replacement Relay
	Screw connector		Spring terminal		
	Catalog Number	Weight	Catalog Number	Weight	Catalog Number
V		kg		kg	
~/~ 12	RSL1PVJU	0.031	RSL1PRJU	0.029	RSL1AB4JD
~/~ 24	RSL1PVBU	0.031	RSL1PRBU	0.029	RSL1AB4BD
~/~ 48	RSL1PVEU	0.031	RSL1PREU	0.029	RSL1AB4ED
~/~ 110	RSL1PVFU	0.031	RSL1PRFU	0.029	RSL1AB4ND
~/~ 230	RSL1PVPU	0.031	RSL1PRPU	0.029	RSL1AB4ND



RSL 1●●●●

### Slim interface relays for customer assembly: relay + socket

Relays with flat, reinforced pins (PCB type)

Sold in lots of 10

1 C/O contact - Thermal current (Ith) 6A

Control circuit voltage (relay coil voltage)	Standard	
	Catalog Number	Weight
V		kg
~/~ 12	RSL1AB4JD	0.006
~/~ 24	RSL1AB4BD	0.006
~/~ 48	RSL1AB4ED	0.006
~/~ 60	RSL1AB4ND	0.006



RSL ZVA● RSL ZRA●

### Sockets equipped with LED and protection circuit

Sold in lots of 10

Operating voltage (input voltage)	For use with relays	Socket type		Spring terminal	
		Screw connector		Spring terminal	
		Catalog Number	Weight	Catalog Number	Weight
V			kg		kg
~/~ 12 and ~/~ 24	RSL1AB4JD RSL1AB4BD	RSLZVA1	0.025	RSLZRA1	0.023
~/~ 48 and ~/~ 60	RSL1AB4ED RSL1AB4ND	RSLZVA2	0.025	RSLZRA2	0.023
~/~ 110	RSL1AB4ND	RSLZVA3	0.025	RSLZRA3	0.023
~/~ 230	RSL1AB4ND	RSLZVA4	0.025	RSLZRA4	0.023



RSL Z2



RSL Z3

### Accessories for sockets

Description	Compatibility	Catalog Number	Weight
Clip-in ID tags (2 sheets of 64 ID tags)	With all sockets	RSLZ5	0.001
Bus jumper (10 x 20-pole jumper)	With all sockets	RSLZ2	0.003
Butterfly isolator (10 isolators)	With all sockets	RSLZ3	0.001



## Slim interface relays, pre-assembled

RSL1PV●● (screw connector)

RSL1PR●● (spring terminals)

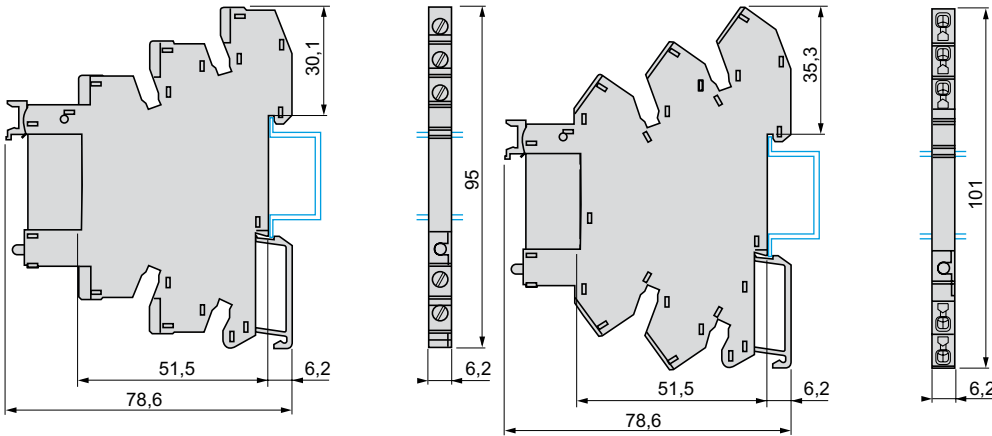

## Relays

RSL1●●●● with flat, reinforced PCB pins

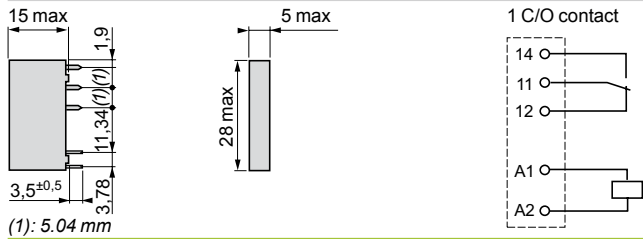

## Sockets

RSLZV●● (screw connector)

RSLZR●● (spring terminals)

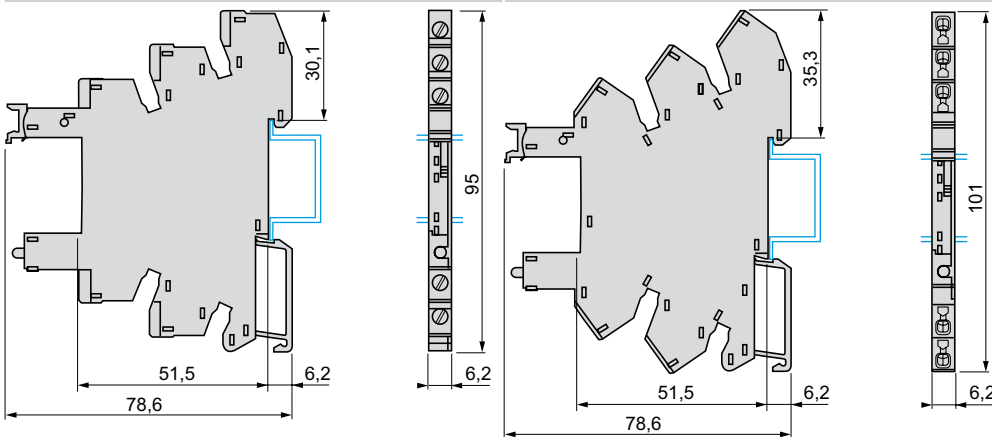

## Socket connections

RSLZV●● (screw connector)

RSLZR●● (spring terminals)

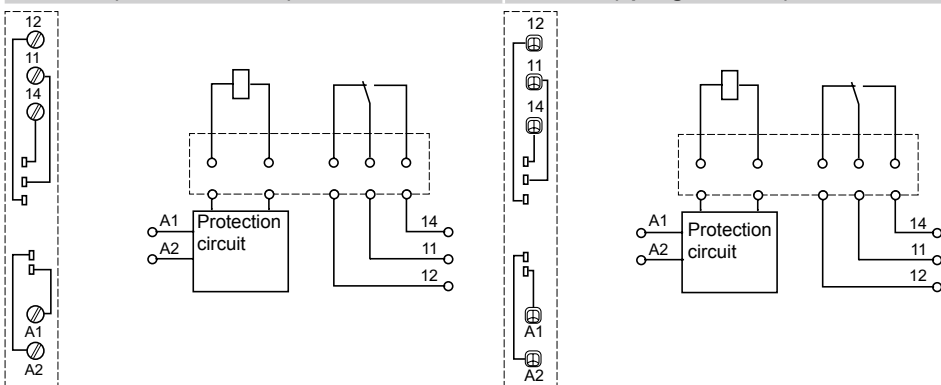



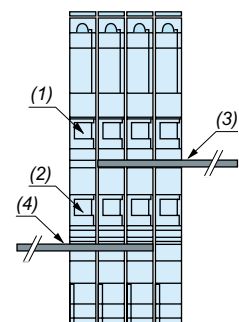

## Example of RSL Z2 bus jumper mounting on sockets

Side view



- (1) A1
- (2) A2
- (3) Bus jumper polarity A1
- (4) Bus jumper polarity A2

Application	Plug-in relays		
	Interface relays	Miniature relays	
			
Number and type of contacts / conventional thermal current (Ith on N/O contact)	1 C/O / 16 A 1 C/O / 12 A 2 C/O / 8 A	2 C/O / 12 A 3 C/O / 10 A 4 C/O / 6 A 4 C/O / 3 A (low level)	
Control circuit voltage	24...240 V 6...110 V	24...240 V 12...220 V	
Type of pins	Flat, PCB type	Quick-connect	
Operational voltage	Up to ~ 400 V / 300 V	Up to 250 V	
Durability (operating cycles)	Electrical, resistive load Mechanical, no-load	100 000 30 000 000	100 000 10 000 000
Functions	LED Mechanical indicator Lockable test button Low level contacts	Yes (with protection modules) – – –	Yes (depending on version) Yes Yes Yes (depending on version)
Type reference	<b>RSB</b>	<b>RXM</b>	
Pages	20	24	
			
Conventional thermal current (Ith)	12 A (1)	10 A	12 A (2)
Contact terminal arrangements	Separate	Mixed	Separate
Connection	Box lug connectors	Screw clamp terminals or box lug connectors	Box lug connectors
Accessories	Protection modules Timer module Retention clip Socket ID tag Mounting adapters for rail Mounting adapters with fixing lugs Bus jumper, 2-pole (Ith = 5 A)	Yes – Yes Yes – – –	Yes – Yes Yes (except RXZ E2M114) Yes Yes –
Associated socket types	<b>RSZE1S●●M</b>	<b>RXZE2M●●●</b>	<b>RXZE2S●●●</b>
Pages	20	24	24

(1) When using relay RSB 1A160●● with socket RSZ E1S48M, terminals must be linked.  
 (2) Except for sockets RXZ E2S11●M: 10 A.

### Universal relays



2 C/O / 10 A  
3 C/O / 10 A  
3 C/O / 3 A (low level)

2 C/O / 10 A  
3 C/O / 10 A

1 C/O / 15 A  
2 C/O / 15 A  
3 C/O / 15 A  
4 C/O / 15 A

24...230 V  
12...220 V

12...110 V

24...230 V  
12...110 V

Cylindrical

Quick-connect

Quick-connect

Up to 250 V

Up to 250 V

100 000  
5 000 000

100 000 (3)  
10 000 000

Yes (depending on version)  
Yes  
Yes  
Yes (depending on version)

Yes (depending on version)  
Yes  
Yes  
-

### RUM

32



12 A

16 A

Mixed

Separate

Mixed

Box lug connectors

Screw clamp terminals

Yes  
Yes  
Yes  
Yes

Yes  
Yes (for 3 and 4-pole)  
Yes (on socket RPZ F1)

-  
-

Yes  
Yes

- Yes

### RUZC•M

### RUZSC•M

### RUZSF3M

### RPZF•

32

32

42

(3) 100 000 for RPM1 and RPM2; 60 000 for RPM3 and RPM4.

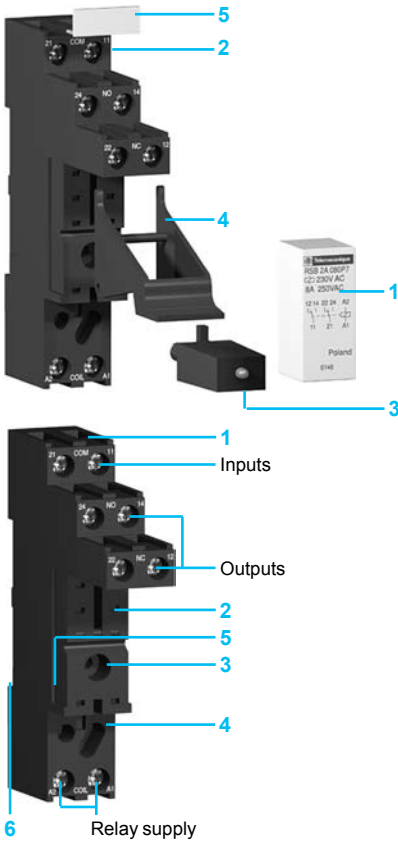

### Introduction of the product range

The RSB interface relay range includes:

- 1 12 A relays with 1 C/O contact , 16 A relays with 1 C/O contact and 8 A relays with 2 C/O contacts.
- 2 Sockets with separate contact terminals.
- 3 Protection modules (diode, diode + LED, RC circuit or varistor + LED).
- 4 Plastic hold-down ejector clip for all sockets.
- 5 Clip-in ID tags for all sockets.

### Socket description

#### Sockets with separate contact terminals (1)

- 1 Box lug connectors.
- 2 Five or eight female contacts for the relay pins.
- 3 Mounting hole for panel mounting.
- 4 Location for protection modules.
- 5 Locking components for plastic hold-down ejector clip.
- 6 Locating slot for mounting on DIN rail.

(1) The inputs and outputs are separated from the relay supply.

### General characteristics

<b>Conforming to standards</b>			IEC/EN 61810-1, UL 508, CSA C22-2 n° 14
<b>Product certifications</b>			cURus File E173076 CNN NRNT2.; CSA File 215736 Class 321107; CE; RoHS compliant
<b>Ambient air temperature</b> around the device	Storage	°C (F)	- 40... + 85 (-40 ... +185)
	Operation	°C (F)	⎯ - 40... + 85 (-40 ... +185), ~ - 40... + 70 (-40 ... +158)
<b>Vibration resistance</b>	Conforming to IEC/EN 60068-2-6		> 10 gn (10..150 Hz)
<b>Degree of protection</b>	Conforming to IEC/EN 60529		IP 40
<b>Shock resistance</b> conforming to IEC/EN 60068-2-27	Opening		5 gn
	Closing		10 gn
<b>Protection category</b>			RT I
<b>Mounting position</b>			Any

### Insulation characteristics

<b>Rated insulation voltage (Ui)</b>	Conforming to IEC/EN 60947	<b>V</b>	400
<b>Rated impulse withstand voltage (Uimp)</b>		<b>kV</b>	3.6 (1.2/50 μs)
<b>Dielectric strength</b> (rms voltage)	Between coil and contact	~ <b>V</b>	5000
	Between poles	~ <b>V</b>	2500
	Between contacts	~ <b>V</b>	1000

### Contact characteristics

Relay type			RSB1A120●●	RSB1A160●●	RSB2A080●●
<b>Number and type of contacts</b>			1 C/O	1 C/O	2 C/O
<b>Contact materials</b>			AgNi		
<b>Conventional thermal current (Ith)</b>	For ambient temperature ≤ 40°C	<b>A</b>	12	16	8
	Conforming to IEC	N.O.	<b>A</b>	12	16
<b>Rated operational current</b> in utilization categories AC-1 and DC-1		N.C.	<b>A</b>	6	4
	<b>Switching current</b>	Minimum	<b>mA</b>	5	
<b>Switching voltage</b>	Maximum		<b>V</b>	~ 400, ⎯ 300	
	Minimum		<b>V</b>	5	
<b>Nominal load (resistive)</b>			<b>A</b>	12 / 250 ~ V	16 / 250 ~ V
			<b>A</b>	12 / 28 ⎯ V	16 / 28 ⎯ V
<b>Switching capacity</b>	Maximum	~	<b>VA</b>	3000	4000
			<b>W</b>	336	448
	Minimum		<b>mW</b>	300	224
<b>Maximum operating rate</b> In operating cycles/hour	No-load			72 000	
	Under load			600	

**Contact characteristics (continued)**

Relay type		RSB 1A120●●	RSB 1A160●●	RSB 2A080●●
<b>Mechanical durability</b>	In millions of operating cycles	≥ 30		
<b>Electrical durability</b>	Resistive load (p.f.)	12 A, 250 V~ (≥ 0.1)	16 A, 250 V~ (≥ 0.07)	8 A, 250 V~ (≥ 0.1)
	In millions of op. cycles	Inductive load		
		See curves below		

**Electrical durability of contacts**

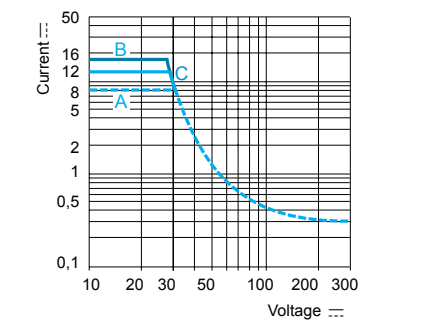
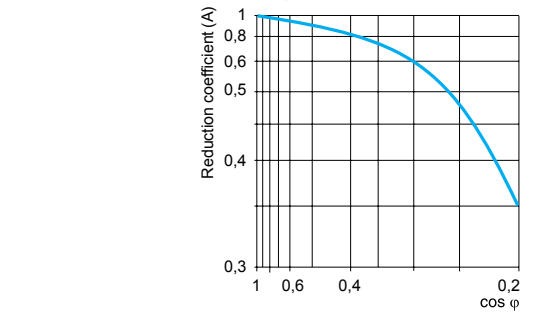
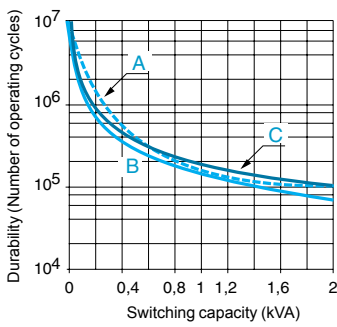

**A RSB 2A080●● B RSB 1A160●● C RSB 1A120●●.** Inductive load durability = resistive load durability x reduction coefficient.

**Coil characteristics**

<b>Average consumption</b>			≈ 0.45 W, ~ 0.75 VA											
<b>Drop-out voltage threshold</b>			≥ ≈ 0.1 U <sub>c</sub> (10% of rated voltage), ≥ ~ 0.15 U <sub>c</sub> (15% of rated voltage)											
<b>Operating time</b> (response time)	Between coil energization and making of the NO contact	~	<b>ms</b>	12										
		~	<b>ms</b>	9										
	Between coil de-energization and making of the NC contact	~	<b>ms</b>	10										
		~	<b>ms</b>	4										
<b>Control circuit voltage U<sub>c</sub></b>		<b>V</b>		<b>6</b>	<b>12</b>	<b>24</b>	<b>48</b>	<b>60</b>	<b>110</b>	<b>120</b>	<b>220</b>	<b>230</b>	<b>240</b>	
<b>Relay control voltage codes</b>				<b>RD</b>	<b>JD</b>	<b>BD</b>	<b>ED</b>	<b>ND</b>	<b>FD</b>	-	-	-	-	
<b>d.c. supply</b>	Average resistance at 20 °C ± 10%	Ω		90	360	1440	5700	7500	25 200	-	-	-	-	
	Operating voltage limits													
	Min.	<b>V</b>		4.8	9.6	19.2	38.4	48	88	-	-	-	-	
	Max.	<b>V</b>		6.6	13.2	26.4	52.8	66	121	-	-	-	-	
<b>Relay control voltage codes</b>				-	-	<b>B7</b>	<b>E7</b>	-	-	<b>F7</b>	<b>M7</b>	<b>P7</b>	<b>U7</b>	
<b>a.c. supply</b> 60 Hz	Average resistance at 20 °C ± 15%	Ω		-	-	400	1550	-	-	10 200	35 500	38 500	42 500	
	Operating voltage limits													
	Min.	50 Hz	<b>V</b>		-	-	19.2	38.4	-	-	96	176	184	192
	Max.	60 Hz	<b>V</b>		-	-	20.4	40.8	-	-	102	187	195.5	204
	Max.	50/60 Hz	<b>V</b>		-	-	26.4	57.6	-	-	144	264	276	288

**Socket characteristics**

<b>Socket type</b>		<b>RSZE1S35M</b>	<b>RSZE1S48M</b>
<b>Relay types used</b>		<b>RSB1A120●●</b>	<b>RSB2A080●●, RSB1A160●● (1)</b>
<b>Contact terminal arrangement</b>		Separate	
<b>Wire connection method</b>		Connector	
<b>Product certifications</b>		CE	
<b>Product certifications</b>		cURus File E172326 CCN SWIV2; CSA File 212916 Class 3211 07; CE; RoHS compliant	

**Electrical characteristics**

<b>Conventional thermal current (I<sub>th</sub>)</b>	<b>A</b>	12
<b>Maximum operating voltage</b>	<b>V~</b>	300

**Insulation characteristics**

<b>Between adjacent output contacts</b>	<b>V<sub>rms</sub></b>	2500
<b>Between input and output contacts</b>	<b>V<sub>rms</sub></b>	2500
<b>Between contacts and DIN rail</b>	<b>V<sub>rms</sub></b>	2500

**General characteristics**

<b>Ambient air temperature</b> around the device	<b>Operation</b>	<b>°C (F)</b>	- 25...+ 85 (-13... +185)
	<b>Storage</b>	<b>°C (F)</b>	- 40...+ 85 (-40... + 185)
<b>Degree of protection</b>	Conforming to IEC/EN 60529		IP 20
<b>Connection</b> box lug connector	Solid wire without cable end	1 conductor	0.5...2.5 mm <sup>2</sup> - AWG 20...AWG 14
		2 conductors	0.5...1.5 mm <sup>2</sup> - AWG 20...AWG 16
	Flexible wire with cable end	1 conductor	0.25...2.5 mm <sup>2</sup> - AWG 22...AWG 14
		2 conductors	0.25...1 mm <sup>2</sup> - AWG 22...AWG 17
<b>Maximum tightening torque / Screw size</b>		<b>Nm</b>	0.8 / M3 screw
<b>Mounting</b>			35 mm DIN rail / panel mount
<b>Mounting on DIN rail</b>			By plastic compression spring
<b>Terminal referencing</b>			IEC
<b>Compatibility with the metal hold-down clip</b>			Yes, plastic
<b>Timer module</b>			No
<b>Protection module</b>			All RZM ●●●
<b>Clip-in ID tags</b>			Available
<b>Wire connection method</b>	Box lug connector		

(1) When using the relay with socket RSZE1S48M, terminals must be linked. See wiring diagrams on page 23.



RSB 1A120JD + RZM 031FPD + RSZ E1S35M



RSB 1A160BD + RSZ E1S48M



RSB 2A080BD + RSZ E1S48M

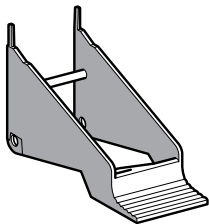

RSZ R215

Relays for standard applications					
Control circuit voltage	Sold in lots of	Number and type of contacts - Thermal current (Ith)			Weight
		1 C/O - 12 A	1 C/O - 16 A	2 C/O - 8 A	
		Catalog number (1)	Catalog number (1)	Catalog number (1)	
<b>V</b>					<b>kg</b>
--- 6	10	RSB1A120RD	RSB1A160RD	RSB2A080RD	0.014
--- 12	10	RSB1A120JD	RSB1A160JD	RSB2A080JD	0.014
--- 24	10	RSB1A120BD	RSB1A160BD	RSB2A080BD	0.014
--- 48	10	RSB1A120ED	RSB1A160ED	RSB2A080ED	0.014
--- 60	10	RSB1A120ND	RSB1A160ND	RSB2A080ND	0.014
--- 110	10	RSB1A120FD	RSB1A160FD	RSB2A080FD	0.014
~ 24	10	RSB1A120B7	RSB1A160B7	RSB2A080B7	0.014
~ 48	10	RSB1A120E7	RSB1A160E7	RSB2A080E7	0.014
~ 120	10	RSB1A120F7	RSB1A160F7	RSB2A080F7	0.014
~ 220	10	RSB1A120M7	RSB1A160M7	RSB2A080M7	0.014
~ 230	10	RSB1A120P7	RSB1A160P7	RSB2A080P7	0.014
~ 240	10	RSB1A120U7	RSB1A160U7	RSB2A080U7	0.014

Sockets 12 A, ~ 300 V					
Contact terminal arrangement	Connection	Relay type	Sold in lots of	Catalog number	Weight kg
Separate	Box lug connectors	RSB1A120●●	10	RSZE1S35M	0.060
		RSB1A160●● (2)	10	RSZE1S48M	0.050
		RSB2A080●●			

Protection modules					
Description	For use with	Voltage	Sold in lots of	Catalog number	Weight
		<b>V</b>			<b>kg</b>
Diode	All sockets	--- 6...230	10	RZM040W	0.003
RC circuit	All sockets	~ 24...60	10	RZM041BN7	0.010
		~ 110...240	10	RZM041FU7	0.010
Diode + green LED	All sockets	--- 6...24	10	RZM031RB	0.004
		--- 24...60	10	RZM031BN	0.004
		--- 110...230	10	RZM031FPD	0.004
Varistor + green LED	All sockets	--- or ~ 6...24	10	RZM021RB	0.005
		--- or ~ 24...60	10	RZM021BN	0.005
		--- or ~ 110...230	10	RZM021FP	0.005

Accessories					
Description	For use with	Sold in lots of	Catalog number	Weight	kg
Plastic hold-down ejector clip	All sockets	10	RSZR215	0.002	
ID tag	All sockets	10	RSZL300	0.001	

(1) To order a relay complete with socket (sold in lots of 20): add suffix S to one of the following voltage codes JD, BD, B7, P7 or F7.  
Example: RSB2A080BD + RSZE1S48M becomes RSB2A080RBS.  
(2) When using the relay with socket RSZE1S48M, terminals must be linked. See wiring diagrams on page 23.

## Dimensions (mm):

### Interface relays

#### RSB1A120●●

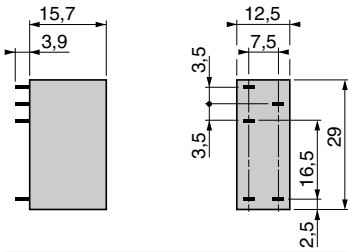

#### RSB2A080●●, RSB1A160●●

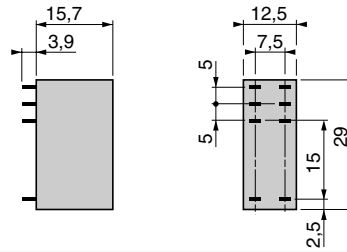

### Sockets

#### RSZE1S35M

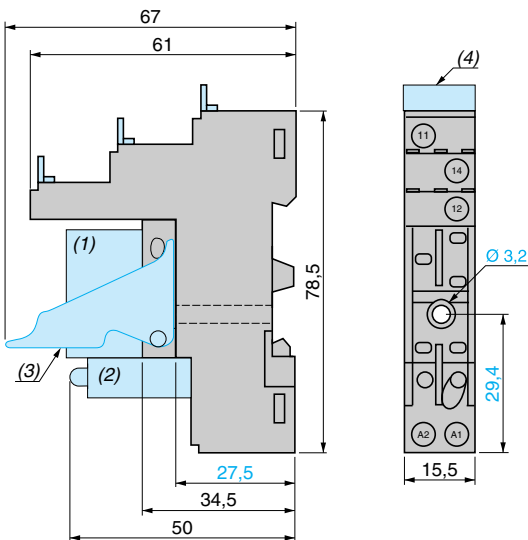

#### RSZE1S48M

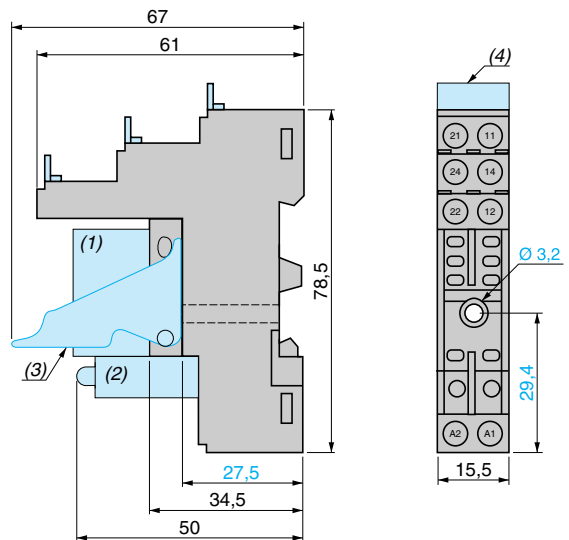

- (1) Relays
- (2) Protection module
- (3) Retention clip
- (4) ID tag

## Wiring diagrams

### Interface relays

#### RSB1A120●●

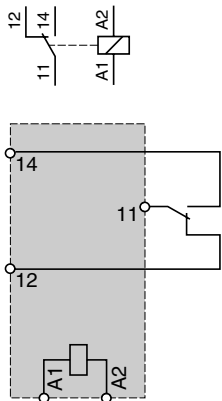

#### RSB1A160●●

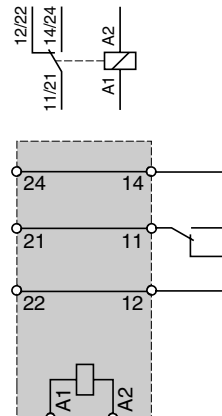

#### RSB2A080●●

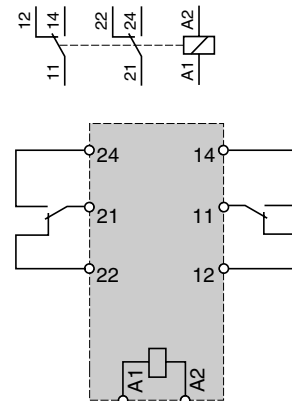

When using relay RSB 1A160●● with socket RSZ E1S48M terminals 11 and 21, 14 and 24, 12 and 22 must be linked

### Protection modules

#### RZM040W

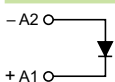

#### RZM041●●●

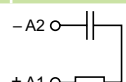

#### RZM031●●●

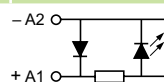

#### RZM021●●●

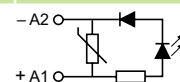

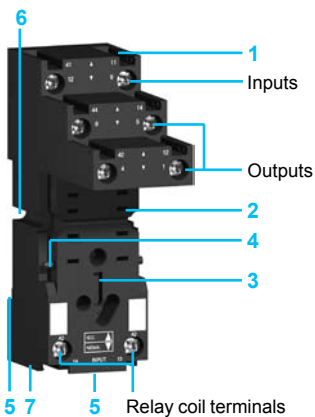
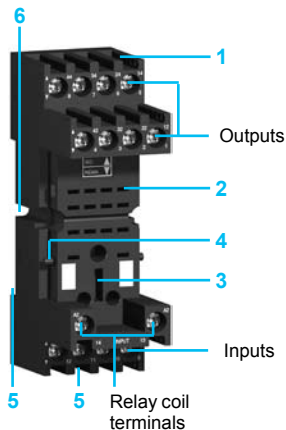
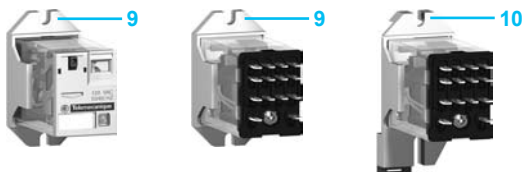
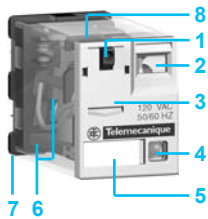
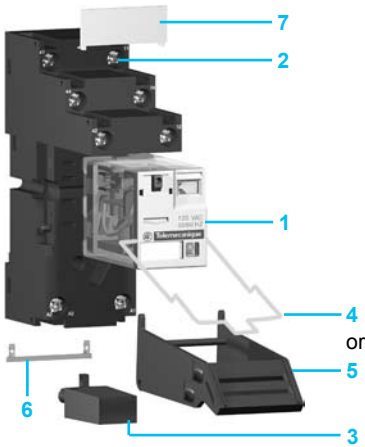

### Introduction of the product range

The RXM miniature relay range includes:

- 1 12 A relays with 2 C/O contacts, 10 A relays with 3 C/O contacts, 6 A relays with 4 C/O contacts and 3 A "low level" relays with 4 C/O contacts. All these relays have the same dimensions.
- 2 Sockets with mixed or separate contact terminals.
- 3 Protection modules (diode, RC circuit or varistor).
- 4 Metal hold-down clip for all sockets.
- 5 Plastic hold-down ejector clip for all sockets.
- 6 2-pole bus jumper that can be used on sockets with separate contact terminals in order to simplify wiring when creating a jumper between the coil terminals.
- 7 Clip-in ID tags for all the sockets except RXZE2M114.

### Relay description

- 1 Spring return push-to-test button for checking contact operation (green:  $\overline{\text{---}}$ , red:  $\sim$ ).
- 2 Mechanical "relay status" indicator.
- 3 Optional removable lock-down door enables continuous engagement of the contacts for test or maintenance purposes. During operation, this lock-down door must always be in the closed position.
- 4 Bipolar LED (depending on version) indicating the relay status.
- 5 Removable ID tag for relay identification.
- 6 Four notches for DIN rail mounting adapter or panel mounting adapter with fixing lugs.
- 7 Eight, eleven or fourteen quick-connect pins.
- 8 Area by which the product can be easily gripped.
- 9 Mounting adapter enabling direct mounting of the relay on a panel.
- 10 Mounting adapter enabling direct mounting of the relay on a DIN rail.

### Socket description

#### Sockets with mixed contact terminals (1)

- 1 Connection by screw clamp terminals or box lug connector.
- 2 Fourteen female contacts for the relay pins.
- 3 Location for protection modules.
- 4 Locking components for plastic and metal hold-down clips.
- 5 Locating slot for mounting on DIN rail.
- 6 Two or four mounting holes for panel mounting.

#### Sockets with separate contact terminals (2)

- 1 Connection by screw connector.
- 2 Eight, eleven or fourteen female contacts for the relay pins.
- 3 Location for protection modules.
- 4 Locking components for plastic and metal hold-down clips.
- 5 Locating slot for mounting on DIN rail.
- 6 Two mounting holes for panel mounting.
- 7 Location for bus jumpers (see mounting on sockets on page 30).

(1) The inputs are mixed with the relay coil terminals, with the outputs being located on the opposite side of the socket.

(2) The inputs and outputs are separated from the relay coil terminals.



### General characteristics

<b>Conforming to standards</b>			IEC/EN 61810-1 (iss. 2), UL 508, CSA C22-2 n° 14
<b>Product certifications</b>			cULus File E164862 CCN NLDX, NLDX7; cURus File E164862 CCN NLDX2, NLDX8; CSA; CE; RoHS compliant
<b>Ambient air temperature</b> around the device	Storage	°C (F)	-40... +85 (-40... +185)
	Operation	°C (F)	-40... +55 (-40... +131)
<b>Vibration resistance</b> conforming to IEC/EN 60068-2-6	In operation		3 gn (10...150 Hz/± 1 mm / 5g/5 cycles)
	Not operating		5 gn (10...150 Hz/± 1 mm / 5g/5 cycles)
<b>Degree of protection</b>			IP 40
<b>Shock resistance</b> conforming to IEC/EN 60068-2-27	Opening		15 gn
	Closing		15 gn
<b>Protection category</b>			RT I
<b>Mounting position</b>			Any

### Insulation characteristics

<b>Rated insulation voltage (U<sub>i</sub>)</b>	<b>V</b>	250 (IEC), 300 (UL, CSA)	
<b>Rated impulse withstand voltage (U<sub>imp</sub>)</b>	<b>kV</b>	4 (1.2/50 μs)	
<b>Dielectric strength</b> (rms voltage)	Between coil and contact	~ V	1550
	Between poles	~ V	1550
	Between contacts	~ V	1500

### Contact characteristics

Relay type			RXM2AB●●●	RXM3AB●●●	RXM4AB●●●	RXM4GB●●●	
<b>Number and type of contacts</b>			2 C/O	3 C/O	4 C/O	4 C/O low level	
<b>Contact materials</b>			AgNi			AgAu - bifurcated	
<b>Conventional thermal current (I<sub>th</sub>)</b>	For ambient temperature ≤ 55 °C	<b>A</b>	12	10	6	3	
<b>Rated operational current</b> in utilization categories AC-1 and DC-1	Conforming to IEC	NO	12	10	6	2	
		NC	6	5	3	1	
	Conforming to UL		12	10	6	3	
<b>Switching current</b>	Minimum	<b>mA</b>	10			3	
<b>Switching voltage</b>	Maximum	<b>V</b>	~ / --- 250 (IEC)				
	Minimum	<b>V</b>	17			5	
<b>Nominal load (resistive)</b>		<b>A</b>	12 / 250 ~ V	10 / 250 ~ V	6 / 250 ~ V	3 / 250 ~ V	
		<b>A</b>	12 / 28 --- V	10 / 28 --- V	6 / 28 --- V	3 / 28 --- V	
<b>Switching capacity</b>	Maximum	~	<b>VA</b>	3000	2500	1500	750
		---	<b>W</b>	336	280	168	84
	Minimum	<b>mW</b>	170			15	
<b>Maximum operating rate</b> In operating cycles	No-load		18 000				
	Under load		1200				
<b>Utilization coefficient</b>			20 %				
<b>Mechanical durability</b>		In millions of operating cycles	10				
<b>Electrical durability</b> In millions of operating cycles	Resistive load		0.1				
	Inductive load		See curves below				

#### Electrical durability of contacts

Resistive load ~

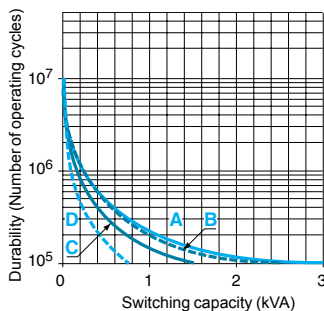

Reduction coefficient for inductive load ~ (depending on power factor cos φ)

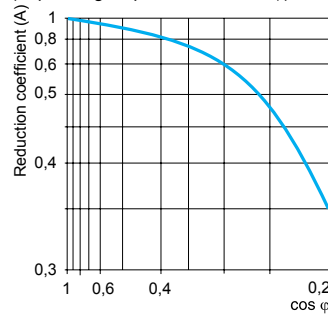

Maximum switching capacity on resistive load ---

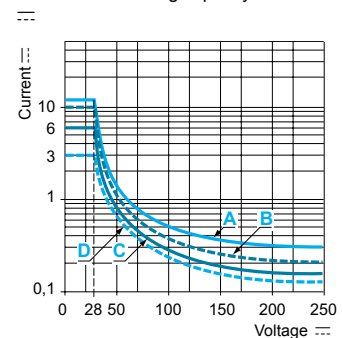

**A** RXM2AB●●●   **B** RXM3AB●●●   **C** RXM4AB●●●   **D** RXM4GB●●●

Inductive load durability = resistive load durability x reduction coefficient.

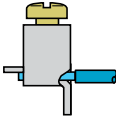
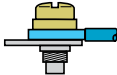
Coil characteristics												
Average consumption		~	VA	1.2								
			W	0.9								
Drop-out voltage threshold		~		≥ 0.15 U <sub>c</sub>								
				≥ 0.1 U <sub>c</sub>								
Operating time (response time)	Between coil energization and making of the NO contact	~	ms	20								
			ms	20								
	Between coil de-energization and making of the NC contact	~	ms	20								
			ms	20								
Control circuit voltage U <sub>c</sub>			V	12	24	48	110	120	125	220	230	240
Relay coil voltage codes				JD	BD	ED	FD	–	GD	MD	–	–
d.c. supply	Average resistance at 20 °C ± 10%		Ω	160	650	2600	11 000	–	11 000	14 000	–	–
	Operating voltage limits	Min.	V	9.6	19.2	38.4	88	–	100	176	–	–
		Max.	V	13.2	26.4	52.8	121	–	138	242	–	–
Relay coil voltage codes				–	B7	E7	–	F7	–	–	P7	U7
a.c. supply	Average resistance at 20 °C ± 15%		Ω	–	180	770	–	4430	–	–	15 000	15 500
	Operating voltage limits	Min.	V	–	19.2	38.4	–	96	–	–	184	192
		Max.	V	–	26.4	52.8	–	132	–	–	253	264
Socket characteristics												
Socket type				RXZE2S108M	RXZE2S111M	RXZE2S114M	RXZE2M114M	RXZE2M114				
Relay types used				RXM2●●●●●	RXM3●●●●●	RXM4●●●●●	RXM2●●●●● (1) RXM4●●●●●	RXM2●●●●● (1) RXM4●●●●●				
Contact terminal arrangement				Separate				Mixed				
Wire connection method				Box lug connectors							Screw clamp terminals	
Product certifications				cURus File E172326 CCN SWIV2, SWIV8; CSA; CE; RoHS compliant								
Conforming to standards				IEC 61984, CE								
Electrical characteristics												
Conventional thermal current (I <sub>th</sub> )			A	12	10							
Maximum operating voltage			V	250 (IEC)								
Insulation characteristics												
Between adjacent output contacts			V <sub>rms</sub>	2500								
Between input and output contacts			V <sub>rms</sub>	2500								
Between contacts and DIN rail			V <sub>rms</sub>	2500								
General characteristics												
Ambient air temperature around the device	Operation		°C (F)	- 40...+ 55 (-40... +131)								
	Storage		°C (F)	- 40...+ 85 (-40... +185)								
Degree of protection			Conforming to IEC/EN 60529								IP 20	
Connection	Solid wire without cable end	1 conductor	0.5...2.5 mm <sup>2</sup> - AWG 20...AWG 14							0.5... 1.5 mm <sup>2</sup> AWG 20...AWG 16		
		2 conductors	0.5... 1.5 mm <sup>2</sup> - AWG 20...AWG 16									
	Flexible wire with cable end	1 conductor	0.25...2.5 mm <sup>2</sup> - AWG 22...AWG 14							0.25...1 mm <sup>2</sup> AWG 22...AWG 17		
		2 conductors	0.25...1 mm <sup>2</sup> - AWG 22...AWG 17									
Maximum tightening torque / Screw size			Nm	1 / M3 screw								
Mounting				35 mm DIN rail / panel mount								
Mounting on DIN rail				By red plastic clip				By metal compression spring		By red plastic clip		
Terminal referencing				IEC, NEMA								
Bus jumper (I <sub>th</sub> : 5 A)				Yes				No				
Compatibility with the plastic hold-down ejector clip				Yes								
Compatibility with the metal hold-down clip				Yes								
Protection module				All RXM040W, RXM041●●, RXM021●●								
Clip-in ID tags				Yes							No	
Wire connection method				Box lug connector							Screw clamp terminals	
												

(1) When mounting relay RXM2●●●●● on socket RXZE2M●●●●●, the thermal current must not exceed 10 A.



RXM2AB1F7



RXM2AB2F7



RXM4GB1F7



RXM4GB2F7

**Miniature relays without LED (sold in lots of 10)**

Control circuit voltage	Number and type of contacts - Thermal current (Ith)					
	2 C/O - 12 A		3 C/O - 10 A		4 C/O - 6 A	
	Catalog number	Weight	Catalog number	Weight	Catalog number	Weight
<b>V</b>		<b>kg</b>		<b>kg</b>		<b>kg</b>
≡ 12	RXM2AB1JD	0.037	RXM3AB1JD	0.037	RXM4AB1JD	0.037
≡ 24	RXM2AB1BD	0.037	RXM3AB1BD	0.037	RXM4AB1BD	0.037
≡ 48	RXM2AB1ED	0.037	RXM3AB1ED	0.037	RXM4AB1ED	0.037
≡ 110	RXM2AB1FD	0.037	RXM3AB1FD	0.037	RXM4AB1FD	0.037
≡ 220	-	-	-	-	RXM4AB1MD	0.037
~ 24	RXM2AB1B7	0.037	RXM3AB1B7	0.037	RXM4AB1B7	0.037
~ 48	RXM2AB1E7	0.037	RXM3AB1E7	0.037	RXM4AB1E7	0.037
~ 120	RXM2AB1F7	0.037	RXM3AB1F7	0.037	RXM4AB1F7	0.037
~ 230	RXM2AB1P7	0.037	RXM3AB1P7	0.037	RXM4AB1P7	0.037
~ 240	-	-	-	-	RXM4AB1U7	0.037

**Miniature relays with LED (sold in lots of 10)**

≡ 12	RXM2AB2JD	0.037	RXM3AB2JD	0.037	RXM4AB2JD	0.037
≡ 24	RXM2AB2BD	0.037	RXM3AB2BD	0.037	RXM4AB2BD	0.037
≡ 48	RXM2AB2ED	0.037	RXM3AB2ED	0.037	RXM4AB2ED	0.037
≡ 110	RXM2AB2FD	0.037	RXM3AB2FD	0.037	RXM4AB2FD	0.037
≡ 125	-	-	-	-	RXM4AB2GD	0.037
~ 24	RXM2AB2B7	0.037	RXM3AB2B7	0.037	RXM4AB2B7	0.037
~ 48	RXM2AB2E7	0.037	RXM3AB2E7	0.037	RXM4AB2E7	0.037
~ 120	RXM2AB2F7	0.037	RXM3AB2F7	0.037	RXM4AB2F7	0.037
~ 230	RXM2AB2P7	0.037	RXM3AB2P7	0.037	RXM4AB2P7	0.037

**Miniature relays with low level contacts, without LED (sold in lots of 10)**

Control circuit voltage	Number and type of contacts Thermal current (Ith)	
	4 C/O - 3 A	
	Catalog number	Weight
<b>V</b>		<b>kg</b>
≡ 12	RXM4GB1JD	0.037
≡ 24	RXM4GB1BD	0.037
≡ 48	RXM4GB1ED	0.037
≡ 110	RXM4GB1FD	0.037
~ 24	RXM4GB1B7	0.037
~ 48	RXM4GB1E7	0.037
~ 120	RXM4GB1F7	0.037
~ 230	RXM4GB1P7	0.037

**Miniature relays with low level contacts, with LED (sold in lots of 10)**

≡ 12	RXM4GB2JD	0.037
≡ 24	RXM4GB2BD	0.037
≡ 48	RXM4GB2ED	0.037
≡ 110	RXM4GB2FD	0.037
~ 24	RXM4GB2B7	0.037
~ 48	RXM4GB2E7	0.037
~ 120	RXM4GB2F7	0.037
~ 230	RXM4GB2P7	0.037
~ 240	RXM4GB2U7	0.037



RXZE2M114M  
+  
Relais RXM4AB2F7



RXZE2S114M  
+  
Relais RXM4AB2F7



RXM041●●7



REXL4●●



RXZ400

Miniature relays without LED (sold in lots of 100)					
Control circuit voltage	Number and type of contacts - Thermal current (Ith)			4 C/O - 6 A	
	2 C/O - 12 A			Catalog number	Weight
	Catalog number	Weight		Catalog number	Weight
V		kg			kg
--- 12	-	-		RXM4AB1JDTQ	0.036
--- 24	RXM2AB1BDTQ	0.037		RXM4AB1BDTQ	0.036
--- 48	-	-		RXM4AB1EDTQ	0.036
--- 110	-	-		RXM4AB1FDTQ	0.036
--- 220	-	-		RXM4AB1MDTQ	0.036
~ 24	RXM2AB1B7TQ	0.037		RXM4AB1B7TQ	0.036
~ 48	-	-		RXM4AB1E7TQ	0.036
~ 120	RXM2AB1F7TQ	0.037		RXM4AB1F7TQ	0.036
~ 230	RXM2AB1P7TQ	0.037		RXM4AB1P7TQ	0.036

Miniature relays with LED (sold in lots of 100)					
--- 24	-	-		RXM4AB2BDTQ	0.036
~ 24	RXM2AB2B7TQ	0.037		RXM4AB2B7TQ	0.036
~ 230	RXM2AB2P7TQ	0.037		RXM4AB2P7TQ	0.036

Sockets					
Contact terminal arrangement	Connection	Relay type	Sold in lots of	Catalog number	Weight kg
Mixed	Screw clamp terminals	RXM2●●●● (3) RXM4●●●●	10	RXZE2M114 (1)	0.048
	Box lug connector	RXM2●●●● (3) RXM4●●●●	10	RXZE2M114M (1)	0.056
Separate	Box lug connector	RXM2●●●●	10	RXZE2S108M (2)	0.058
		RXM3●●●●	10	RXZE2S111M (1)	0.066
		RXM4●●●●	10	RXZE2S114M (1)	0.070

Protection modules					
Description	Voltage	For use with	Sold in lots of	Catalog number	Weight kg
	V				kg
Diode	--- 6...250	All sockets	20	RXM040W	0.003
RC circuit	~ 24...60	All sockets	20	RXM041BN7	0.010
	~ 110...240	All sockets	20	RXM041FU7	0.010
Varistor	~ / --- 6...24	All sockets	20	RXM021RB	0.030
	~ / --- 24...60	All sockets	20	RXM021BN	0.030
	~ / --- 110...240	All sockets	20	RXM021FP	0.030

Timing relays			
Description	For use with	Catalog number	Weight kg
2 or 4 timed C/O contacts (function A)	Sockets RXZE●●●●●	REXL2●● (4)	-
		REXL4●● (4)	-

Accessories				
Description	For use with	Sold in lots of	Catalog number	Weight kg
Metal hold-down clip	All sockets	10	RXZ400	0.001
Plastic hold-down ejector clip	All sockets	10	RXZR335	0.005
Bus jumper 2-pole (Ith: 5 A)	All sockets with separate contacts	10	RXZS2	0.005
Mounting adapter for DIN rails (5)	All relays	10	RXZE2DA	0.004
Mounting adapter with fixing lugs for panel	All relays	10	RXZE2FA	0.002
Clip-in ID tags	All relays (sheet of 108 ID tags)	10	RXZL520	0.080
	All sockets except RXZ E2M114	10	RXZL420	0.001

(1) Thermal current Ith: 10 A  
 (2) Thermal current Ith: 12 A  
 (3) When mounting relay RXM2●●●●● on socket RXZE2M●●●●●, the thermal current must not exceed 10 A.  
 (4) Please consult the "Zelio Time - timing relays" catalog.  
 (5) Test button becomes inaccessible.

**Dimensions (mm):**

**Miniature relays**

RXM●●●●●

Common view

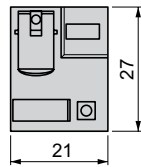
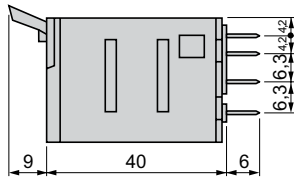

RXM2

Pin side view

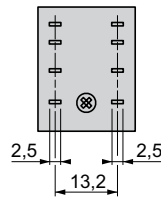

RXM3

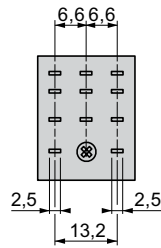

RXM4

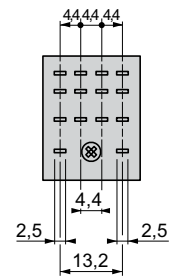

**Sockets**

RXZE2M114

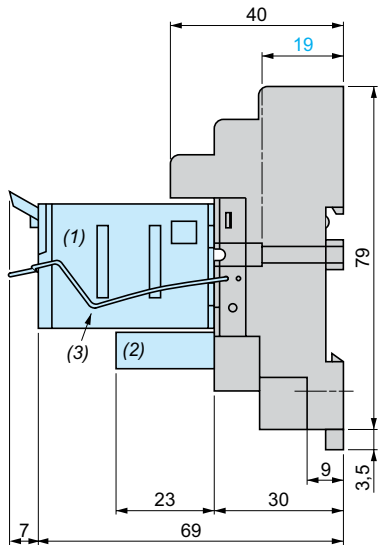

RXZE2M114M

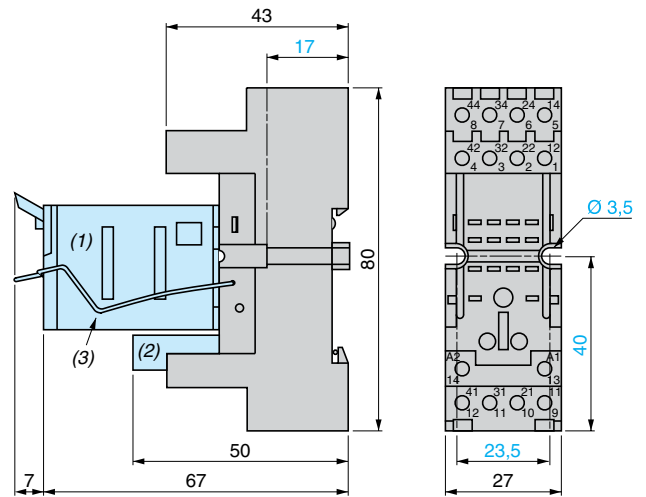

Common side view

RXZE2S108M

RXZE2S111M

RXZE2S114M

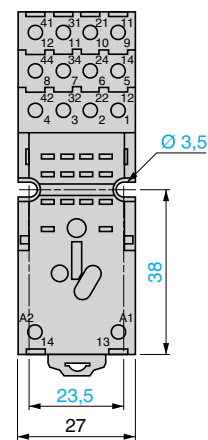
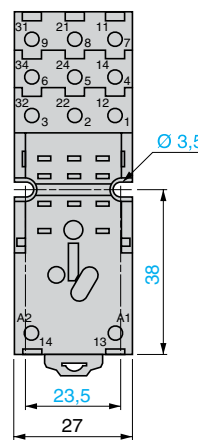
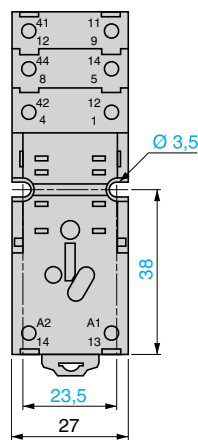
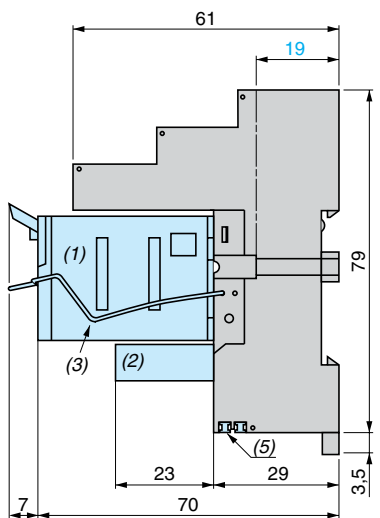

- (1) Relay
- (2) Protection module
- (3) Metal hold-down clip
- (4) 2 elongated holes Ø 3.5 x 6.5
- (5) 2 bus jumpers

**Dimensions (mm):**

**Plastic hold-down clip and clip-in ID tags**

RXZR335

RXZL420

Mounting on all sockets (1)

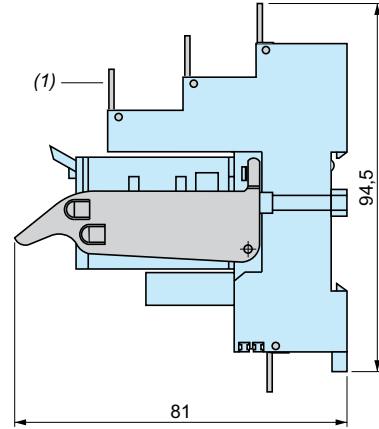
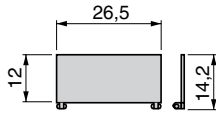
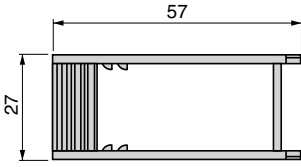

(1) Clip-in ID tags for all sockets except RXZE2M114

**Bus jumper**

RXZS2

Mounting on sockets with separate contacts  
(view from below)

**Metal hold-down clip**

RXZ400

Example of bus jumper mounting on sockets

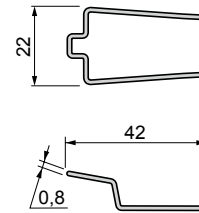
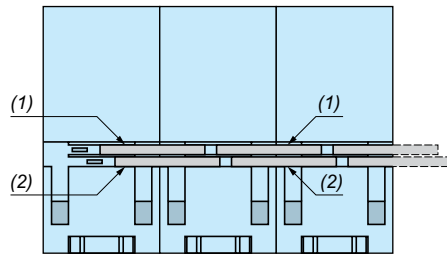
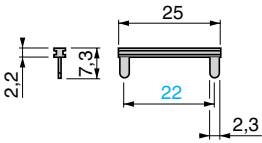

(1) 2 bus jumpers (polarity A2)  
(2) 2 bus jumpers (polarity A1)

**Mounting adapter for DIN rails (1)**

RXZE2DA

**Mounting adapter for panel**

RXZE2FA

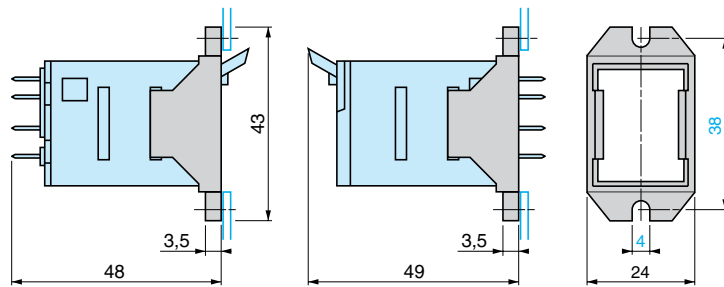
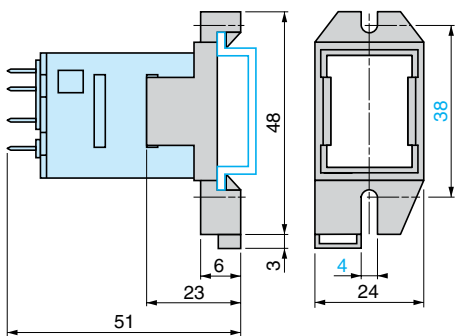

(1) Test button becomes inaccessible

### Internal connections

#### Miniature relays

##### RXM2●●●●●

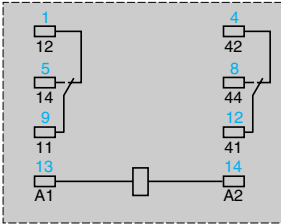
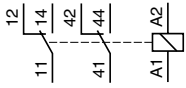

##### RXM3●●●●●

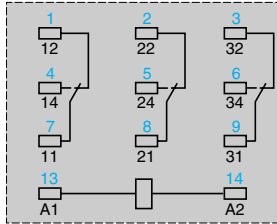
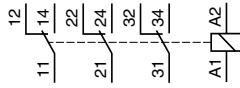

##### RXM4●●●●●

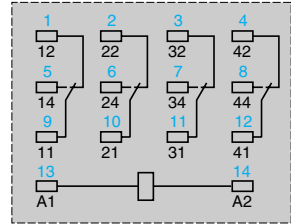
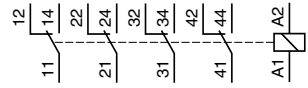

Symbols shown in blue correspond to Nema marking.

#### Sockets

##### RXZE2M114

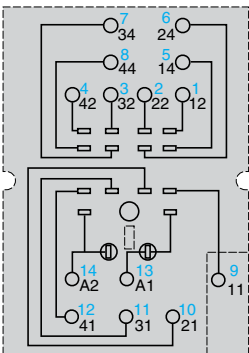

##### RXZE2M114M

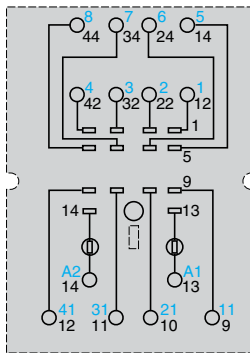

Symbols shown in blue correspond to Nema marking.

##### RXZE2S108M

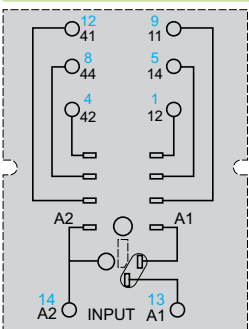

##### RXZE2S111M

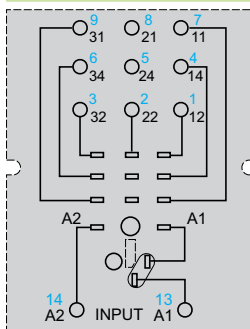

##### RXZE2S114M

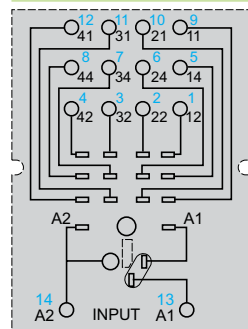

Symbols shown in blue correspond to Nema marking.

#### Protection modules

##### RXM040W

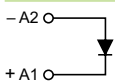

##### RXM041●●●

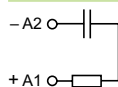

##### RXM021●●●

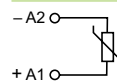

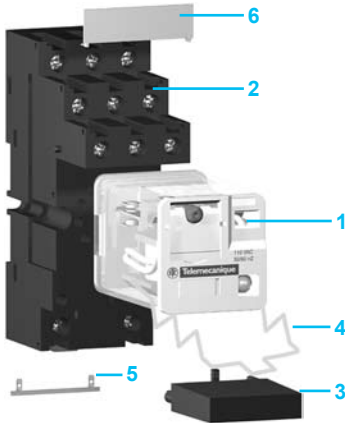

### Introduction of the product range

The RUM universal relay range includes:

- 1 10 A relays with 2 and 3 C/O contacts, with cylindrical or quick-connect terminals, and 3 A low level relays with 3 C/O contacts, with cylindrical pins. All RUM relays have the same dimensions.
- 2 Sockets with mixed or separate contact terminals.
- 3 Protection modules (diode, RC circuit or varistor) or 1 timer module.
- 4 Metal hold-down clip for all sockets.
- 5 2-pole bus jumper that can be used on sockets with separate contact terminals in order to simplify wiring when creating a jumper between the coil terminals.
- 6 Clip-in ID tags for the sockets.

### Relay description

- 1 Spring return push-to-test button for checking contact operation (green: ---, red: ~).
- 2 Mechanical "relay status" indicator.
- 3 Optional removable lock-down door enables continuous engagement of the contacts for test or maintenance purposes. During operation, this lock-down door must always be in the closed position.
- 4 Bipolar LED (depending on version) indicating the relay status.
- 5 Removable ID tag for relay identification.
- 6 Area by which the product can be easily gripped.
- 7 Eight or eleven cylindrical pins.
- 8 Eight or eleven quick-connect pins

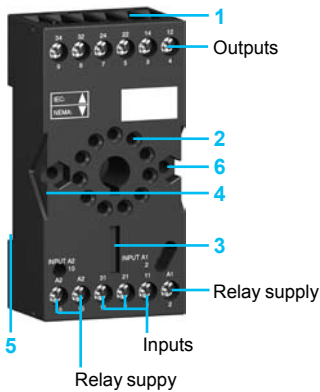

### Socket description

#### Sockets with mixed contact terminals (1)

- 1 Box lug connectors.
- 2 Eight or eleven female contacts for the relay cylindrical pins.
- 3 Location for protection modules or the timer module.
- 4 Locking component for metal hold-down clip.
- 5 Locating slot for mounting on DIN rail.
- 6 Two mounting holes for panel mounting.

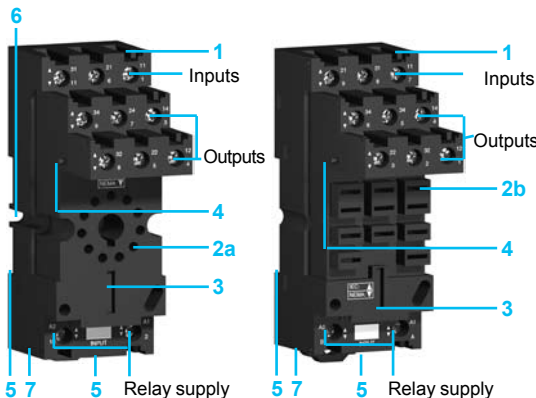

#### Sockets with separate contact terminals (2)

- 1 Box lug connectors.
- 2 a Eight or eleven female contacts for the relay cylindrical pins.  
b Eleven female contacts for the relay flat pins.
- 3 Location for protection modules or the timer module.
- 4 Locking component for metal hold-down clip.
- 5 Locating slot for mounting on DIN rail.
- 6 Two mounting holes for panel mounting.
- 7 Location for bus jumpers (see mounting on sockets on page 38).

(1) The inputs are mixed with the relay coil terminals, with the outputs being located on the opposite side of the socket.

(2) The inputs and outputs are separated from the relay coil terminals.



### General characteristics

<b>Conforming to standards</b>			IEC/EN 61810-1 (iss. 2), UL 508, CSA C22-2 n° 14
<b>Product certifications</b>			cULus File E164862 CCN NLDX, NLDX7; cURus File E164862 CCN NLDX2, NLDX8; CSA; CE; RoHS compliant
<b>Ambient air temperature</b> around the device	Storage	°C (F)	-40... +85 (-40... +185)
	Operation	°C (F)	-40... +55 (-40... +131)
<b>Vibration resistance</b> conforming to IEC/EN 60068-2-6	In operation		3 gn (10...150 Hz/± 1 mm / 5g/5 cycles)
	Not operating		4 gn (10...150 Hz/± 1 mm / 5g/5 cycles)
<b>Degree of protection</b> conforming to IEC/EN 60529			IP 40
<b>Shock resistance</b> conforming to IEC/EN 60068-2-27	Opening		10 gn
	Closing		10 gn
<b>Protection category</b>			RT I
<b>Mounting position</b>			Any

### Insulation characteristics

<b>Rated insulation voltage (Ui)</b>	Conforming to IEC/EN 60947	V	250 (IEC), 300 (UL, CSA)
<b>Rated impulse withstand voltage (Uimp)</b>		kV	4 (1.2/50 μs)
<b>Dielectric strength</b> (rms voltage)	Between coil and contact	~ V	1550
	Between poles	~ V	1550
	Between contacts	~ V	1500

### Contact characteristics

Relay type			RUMF2●●●	RUMF3●●●	RUMC2●●●	RUMC3A●●	RUMC3G●●	
<b>Number and type of contacts</b>			2 C/O	3 C/O	2 C/O	3 C/O	3 C/O low level	
<b>Contact materials</b>			AgNi				AgAu	
<b>Conventional thermal current (Ith)</b> For ambient temperature ≤ 55°C		A	10				3	
		A	10				2	
<b>Rated operational current</b> in utilization categories AC-1 and DC-1	Conforming to IEC	NO	A	5				1
		NC	A	5				1
	Conforming to UL		A	16 / ~ 277 V 12 / ~ 28 V				3
<b>Switching current</b>	Minimum	mA	10				3	
<b>Switching voltage</b>	Maximum	V	~ 250 (IEC)					
	Minimum	V	17				5	
<b>Nominal load (resistive)</b>		A	10 / 250 ~ V				3 / 250 ~ V	
		A	10 / 28 ~ V				3 / 28 ~ V	
<b>Switching capacity</b>	Maximum	~	VA	2500				750
		~	W	280				84
	Minimum	mW	170				15	
<b>Maximum operating rate</b> In operating cycles/hour	No-load		18 000					
	Under load		1200					
<b>Utilization coefficient</b>			20 %					
<b>Mechanical durability</b>	In millions of operating cycles		5					
<b>Electrical durability</b> In millions of operating cycles	Resistive load		0.1					
	Inductive load		See curves below					

**Electrical durability of contacts**  
Resistive load ~

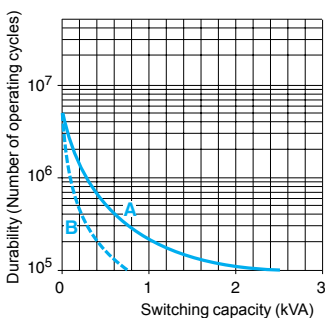

Reduction coefficient for inductive load ~  
(depending on power factor cos φ)

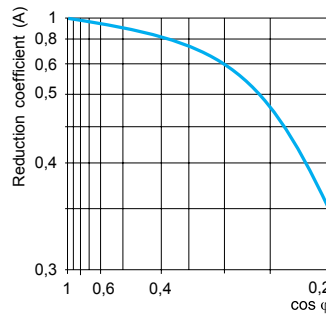

Maximum switching capacity on resistive load ~

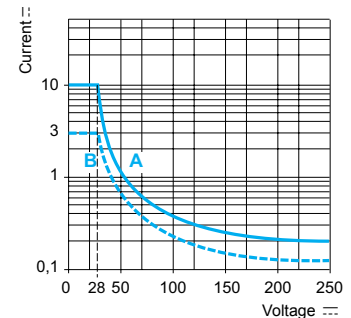

**A RUMF●●●●●, RUMC2●●●, RUMC3A●●●    B RUMC3G●●●**

Inductive load durability = resistive load durability x reduction coefficient.

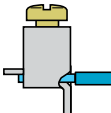
Coil characteristics												
Average consumption		~ 	VA	2...3								
			W	1.4								
Drop-out voltage threshold		~ 		≥ 0.15 Uc								
				≥ 0.1 Uc								
Operating time (response time)	Between coil energization and making of the NO contact	~ 	ms	20								
			ms	20								
	Between coil de-energization and making of the NC contact	~ 	ms	20								
			ms	20								
Control circuit voltage Uc			V	12	24	48	60	110	120	125	220	230
Relay coil voltage codes				JD	BD	ED	ND	FD	–	GD	MD	–
d.c. supply	Average resistance at 20 °C ± 10%		Ω	120	470	1800	2790	10 000	–	10 000	3700	–
	Operating voltage limits	Min.	V	9.6	19.2	38.4	48	88	–	100	176	–
		Max.	V	13.2	26.4	52.8	66	121	–	137.5	242	–
Relay control voltage codes				–	B7	E7	–	–	F7	–	–	P7
a.c. supply	Average resistance at 20 °C ± 15%		Ω	–	72	290	–	–	1700	–	–	7200
	Operating voltage limits	Min.	V	–	19.2	38.4	–	–	96	–	–	184
		Max.	V	–	26.4	52.8	–	–	132	–	–	253
Socket characteristics												
Socket type				RUZC2M	RUZC3M	RUZSC2M	RUZSC3M	RUZSF3M				
Relay types used				RUMC2●●●●●	RUMC3●●●●●	RUMC2●●●●●	RUMC3●●●●●	RUMF●●●●●				
Contact terminal arrangement				Mixed			Separate					
Wire connection method				Connector								
Product certifications				cURus File E172326 CCN SWIV2, SWIV8; CSA; CE; RoHS compliant								
Conforming to standards				IEC 61984, CE								
Electrical characteristics												
Conventional thermal current (I <sub>th</sub> )			A	10			12					
Maximum operating voltage			V	250 (IEC)								
Insulation characteristics												
Between adjacent output contacts			V <sub>rms</sub>	2500								
Between input and output contacts			V <sub>rms</sub>	2500								
Between contacts and DIN rail			V <sub>rms</sub>	2500								
General characteristics												
Ambient air temperature around the device	Operation		°C (F)	- 40...+ 55 (-40... +131)								
	Storage		°C (F)	- 40...+ 85 (-40... +185)								
Degree of protection		Conforming to IEC/EN 60529		IP 20								
Connection	Solid wire	1 conductor		0.5...2.5 mm <sup>2</sup> - AWG 20...AWG 14								
	without cable end	2 conductors		0.5...1.5 mm <sup>2</sup> - AWG 20...AWG 16								
	Flexible wire	1 conductor		0.25...2.5 mm <sup>2</sup> - AWG 22...AWG 14								
	with cable end	2 conductors		0.25...1 mm <sup>2</sup> - AWG 22...AWG 17								
Maximum tightening torque / Screw size			Nm	1 / M3.3 screw								
Mounting				35 mm DIN rail / panel								
Mounting on DIN rail				By red plastic clip								
Terminal referencing				IEC, NEMA								
Bus jumper (I <sub>th</sub> : 5 A)				No			Yes					
Compatibility with the metal hold-down clip				Yes								
Timer module				Yes								
Protection module				All RUW24●●●								
Clip-in ID tags				No			Yes					
Wire connection method		Box lug connector										



RUM●●AB1F7



RUM●●AB2F7

### Product selection

#### Relays for standard applications, without LED (sold in lots of 10)

Pins	Control circuit voltage	Number and type of contacts - Thermal current (Ith)				
		2 C/O - 10 A	3 C/O - 10 A			
		Catalog number	Weight	Catalog number	Weight	
	V		kg		kg	
Cylindrical	⋯ 12	RUMC2AB1JD	0.085	RUMC3AB1JD	0.088	
	⋯ 24	RUMC2AB1BD	0.085	RUMC3AB1BD	0.088	
	⋯ 48	RUMC2AB1ED	0.085	RUMC3AB1ED	0.088	
	⋯ 60	–	–	RUMC3AB1ND	0.088	
	⋯ 110	RUMC2AB1FD	0.085	RUMC3AB1FD	0.088	
	⋯ 125	–	–	RUMC3AB1GD	0.088	
	⋯ 220	–	–	RUMC3AB1MD	0.088	
	~ 24	RUMC2AB1B7	0.085	RUMC3AB1B7	0.088	
	~ 48	RUMC2AB1E7	0.085	RUMC3AB1E7	0.088	
	~ 120	RUMC2AB1F7	0.085	RUMC3AB1F7	0.088	
	~ 230	RUMC2AB1P7	0.085	RUMC3AB1P7	0.088	
	Flat (quick-connect)	⋯ 12	RUMF2AB1JD	0.080	RUMF3AB1JD	0.082
		⋯ 24	RUMF2AB1BD	0.080	RUMF3AB1BD	0.082
		⋯ 48	RUMF2AB1ED	0.080	RUMF3AB1ED	0.082
⋯ 110		RUMF2AB1FD	0.080	RUMF3AB1FD	0.082	
~ 24		RUMF2AB1B7	0.080	RUMF3AB1B7	0.082	
~ 48		RUMF2AB1E7	0.080	RUMF3AB1E7	0.082	
~ 120		RUMF2AB1F7	0.080	RUMF3AB1F7	0.082	
~ 230		RUMF2AB1P7	0.080	RUMF3AB1P7	0.082	

#### Relays for standard applications, with LED (sold in lots of 10)

Cylindrical	⋯ 12	RUMC2AB2JD	0.085	RUMC3AB2JD	0.088	
	⋯ 24	RUMC2AB2BD	0.085	RUMC3AB2BD	0.088	
	⋯ 48	RUMC2AB2ED	0.085	RUMC3AB2ED	0.088	
	⋯ 60	–	–	RUMC3AB2ND	0.088	
	⋯ 110	RUMC2AB2FD	0.085	RUMC3AB2FD	0.088	
	⋯ 125	–	–	RUMC3AB2GD	0.088	
	~ 24	RUMC2AB2B7	0.085	RUMC3AB2B7	0.088	
	~ 48	RUMC2AB2E7	0.085	RUMC3AB2E7	0.088	
	~ 120	RUMC2AB2F7	0.085	RUMC3AB2F7	0.088	
	~ 230	RUMC2AB2P7	0.085	RUMC3AB2P7	0.088	
	Flat (quick-connect)	⋯ 12	RUMF2AB2JD	0.084	RUMF3AB2JD	0.082
		⋯ 24	RUMF2AB2BD	0.084	RUMF3AB2BD	0.082
		⋯ 48	RUMF2AB2ED	0.084	RUMF3AB2ED	0.082
		⋯ 110	RUMF2AB2FD	0.084	RUMF3AB2FD	0.082
~ 24		RUMF2AB2B7	0.084	RUMF3AB2B7	0.082	
~ 48		RUMF2AB2E7	0.084	RUMF3AB2E7	0.082	
~ 120		RUMF2AB2F7	0.084	RUMF3AB2F7	0.082	
~ 230		RUMF2AB2P7	0.084	RUMF3AB2P7	0.082	

#### Relays with low level contacts, with LED (sold in lots of 10)

Pins	Control circuit voltage	Number and type of contacts Thermal current (Ith)	
		3 C/O - 3 A	
		Catalog number	Weight
	V		kg
Cylindrical	~ 24	RUMC3GB2BD	0.086
	~ 48	RUMC3GB2ED	0.086
	~ 24	RUMC3GB2B7	0.086
	~ 48	RUMC3GB2E7	0.086
	~ 120	RUMC3GB2F7	0.086
	~ 230	RUMC3GB2P7	0.086



RUC3M + relais RUMC3



RUW241P7



RUW101MW



RUZC200



RUZS2

### Product selection (continued)

#### Sockets

Contact terminal arrangement	Connection	Relay type	Sold in lots of	Catalog number	Weight kg
Mixed	Box lug connector	RUMC2	10	RUZC2M	0.054
		RUMC3	10	RUZC3M	0.054
Separate	Box lug connector	RUMC2	10	RUZSC2M	0.095
		RUMC3	10	RUZSC3M	0.100
		RUMF2	10	RUZSF3M	0.095
		RUMF3			

#### Protection modules

Description	For use with	Voltage	Sold in lots of	Catalog number	Weight kg
		<b>V</b>			<b>kg</b>
Diode	All sockets	6...250	10	RUW240BD	0.004
RC circuit	All sockets	110...240	10	RUW241P7	0.004
Varistor	All sockets	24	10	RUW242B7	0.004
		240	10	RUW242P7	0.004

#### Timer module

Description	For use with	Voltage	Catalog number	Weight kg
		<b>V</b>		<b>kg</b>
Multifunction	All sockets	24... 240	RUW101MW	0.020

#### Timing relays

Description	For use with	Catalog number	Weight kg
2 timed C/O contacts (single-function or multifunction)	On sockets RUC3M	RE48A (1)	–

#### Accessories

Description	For use with	Sold in lots of	Catalog number	Weight kg
Metal hold-down clip	All sockets	10	RUZC200	0.001
Bus jumper 2-pole (Ith : 5 A)	All sockets with separate contacts	10	RUZS2	0.005
Clip-in ID tags	All relays (sheet of 108 ID tags)	10	RXZL520	0.080
	All sockets with separate contacts	10	RUZL420	0.001

(1) Please consult the "Zelio Time timing relays" catalog.

**Dimensions (mm):**

**Universal relays**

**RUMC●●**

**RUMF●●**



**Sockets**

**Common side view**

**RUZC2M**

**RUZC3M**

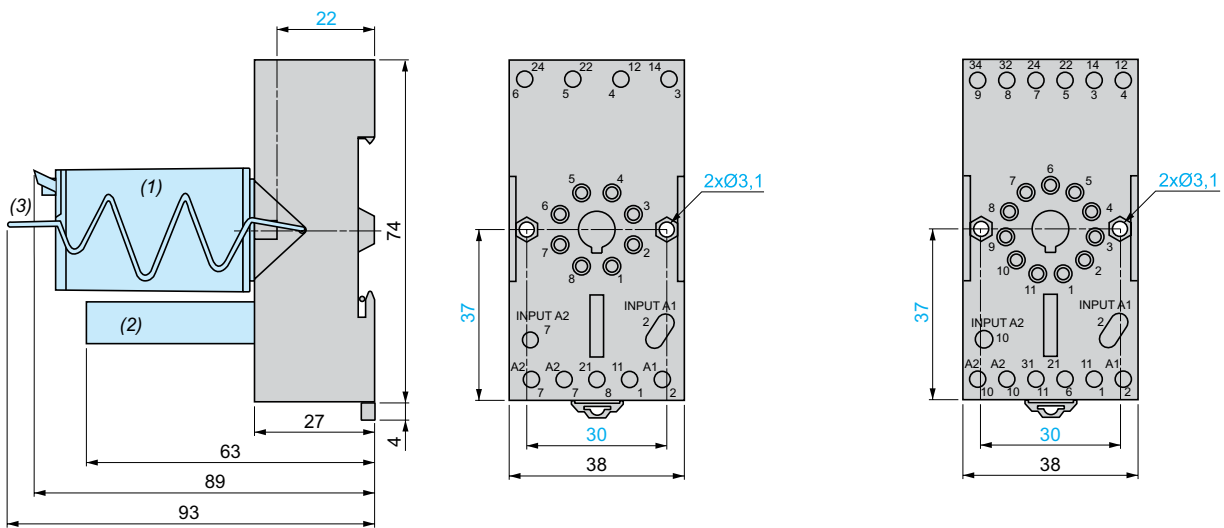

**RUZSC2M**

**RUZSC3M**

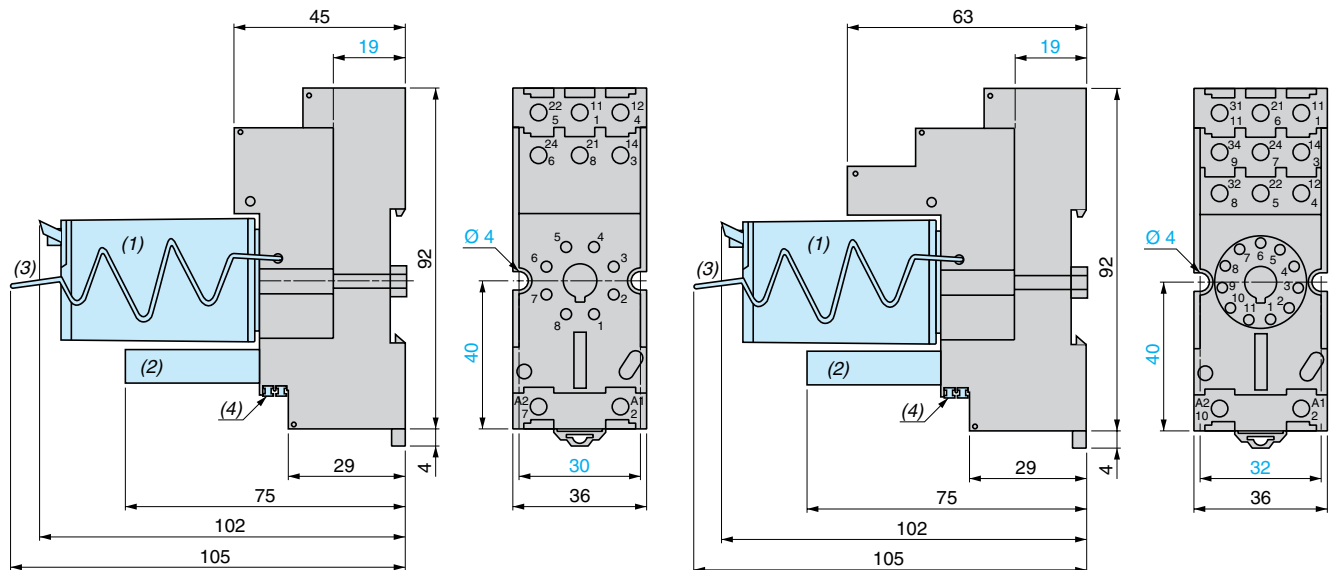

- (1) Relays
- (2) Protection module
- (3) Retention clip
- (4) 2 bus jumpers

## Dimensions (mm):

### Sockets (continued)

#### RUZSF3M

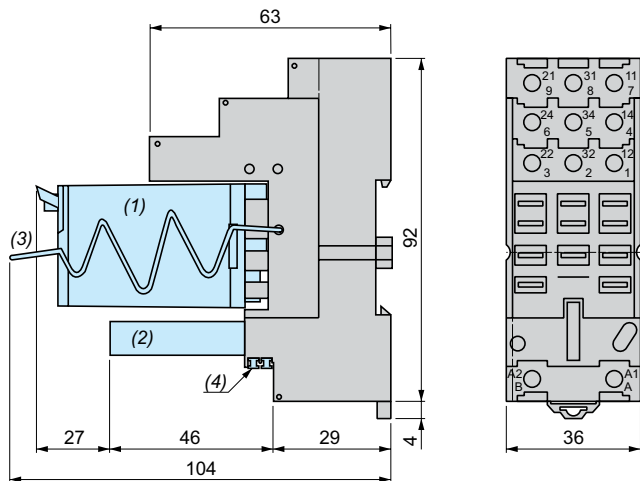

- (1) Relays
- (2) Protection module
- (3) Retention clip
- (4) 2 bus jumpers

### Metal hold-down clip and plastic ID tags

#### RUZC200

#### Mounting

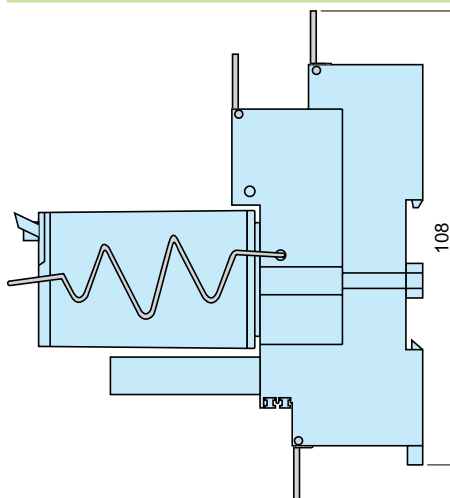
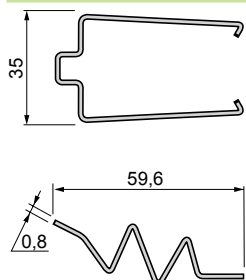

#### RUZL420

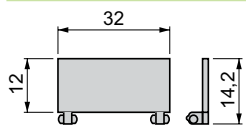

### Bus jumper

#### RUZS2

#### Mounting on sockets with separate contacts (view from below)

#### Example of bus jumper mounting on sockets

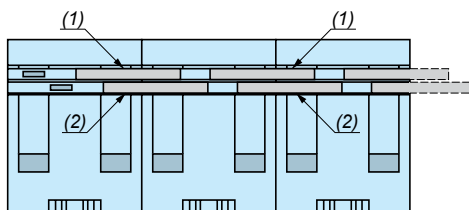
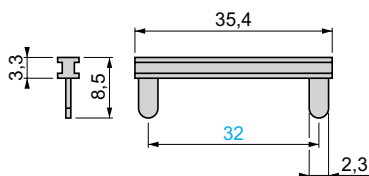

- (1) 2 bus jumpers (polarity A2)
- (2) 2 bus jumpers (polarity A1)

### Wiring diagrams

#### Universal relays

##### RUM2AB●●●

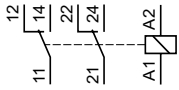

##### RUMC3●●●●●

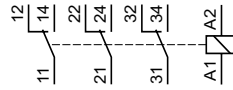

##### RUMF3AB●●●

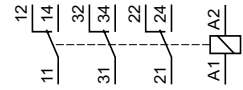

##### RUMC2AB●●●

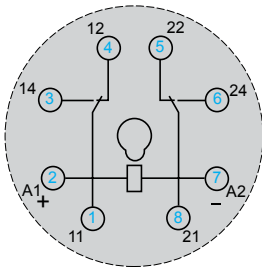

##### RUMF2AB●●●

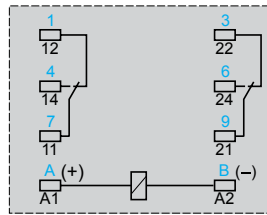

##### RUMC3●●●●●

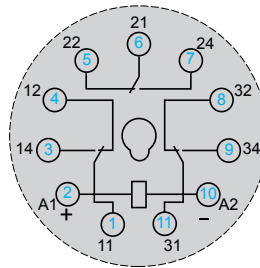

##### RUMF3AB●●●

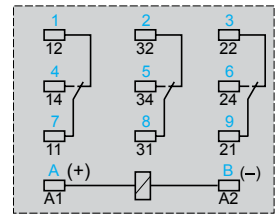

Symbols shown in blue correspond to Nema marking.

#### Sockets

##### RUZC2M

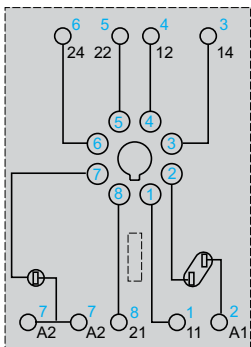

##### RUZC3M

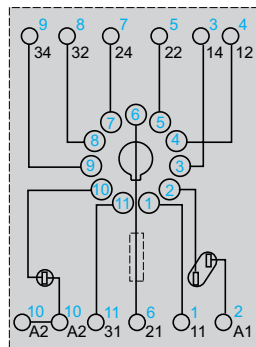

##### RUZSC2M

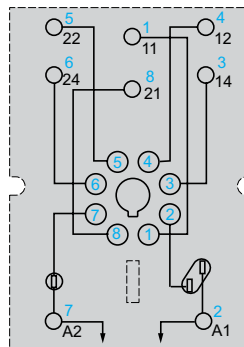

##### RUZSC3M

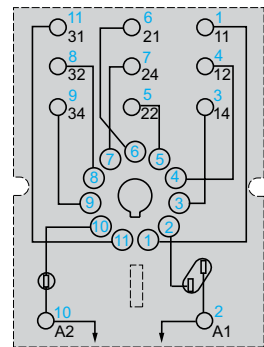

Symbols shown in blue correspond to Nema marking.

##### RUZSF3M

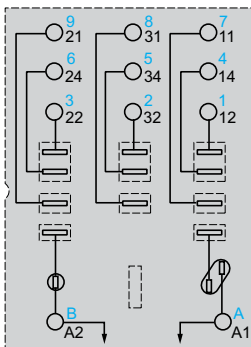

Symbols shown in blue correspond to Nema marking.

## Wiring diagrams (continued)

### Protection modules

#### RUW240BD

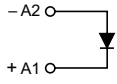

#### RUW241P7

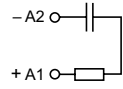

#### RUW242●●

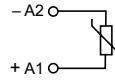



### Multifunction timer module RUW101MW

#### Programming

#### Timing range selection

Function selection  
Timing range selection

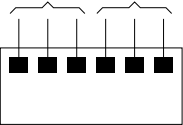

0.1...1 s



0.1...10 s



0.1...1 min



1...10 min



0.1...1 h



1...10 h



0.1...1 day



1...10 days

#### Function selection

##### Selection

##### Function

##### Control

##### Function diagram

##### Control scheme

	<b>On-delay Timer E</b>	Series control		
	<b>Monostable with maintained control Wu</b>	Series control		
	<b>Flashing relay, starting On-delay phase Bi</b>	Series control		
	<b>Flashing relay, starting Off-delay phase Bp</b>	Series control		
	<b>Off-delay timer R</b>	Control by external contact (S)		
	<b>Monostable with pulse control Ws</b>	Control by external contact (S)		
	<b>Monostable, starting on de-energization Wa</b>	Control by external contact (S)		
	<b>On-delay Timer Es</b>	Control by external contact (S)		

Power off

Contact open

U : voltage

S : external control

Power on

Contact closed

R : relay RUM ●●●

t : adjustable time delay

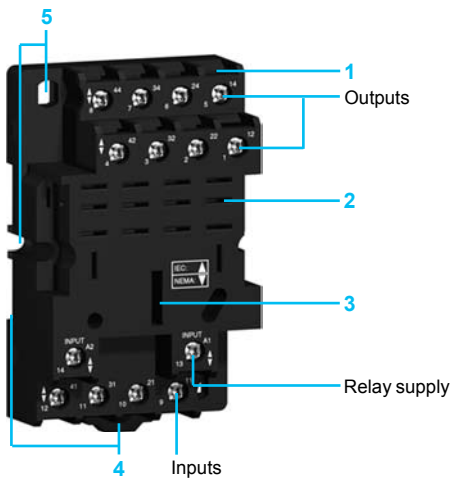
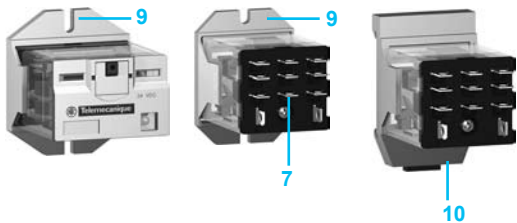
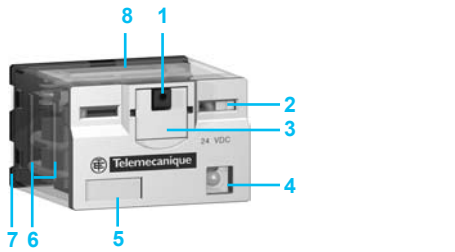
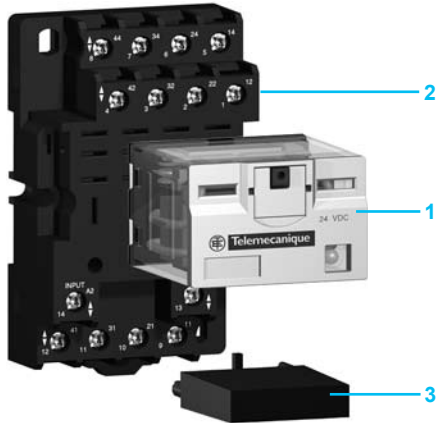

### Introduction of the product range

The RPM power relay range includes:

- 1 15 A relays with 1, 2, 3 and 4 C/O (SPDT, DPDT, 3PDT and 4PDT) contacts.
- 2 Sockets with mixed contact terminals.
- 3 Protection modules (diode, RC circuit or varistor) or 1 timer module. Please note that the timer module can only be used with 3-pole or 4-pole sockets.
- 4 Metal hold-down clip for single-contact relays (not shown).

### Relay description

- 1 Spring return push-to-test button for checking contact operation (green: —, red: ~).
- 2 Mechanical “relay status” indicator.
- 3 Removable lock-down door enables continuous engagement of the contacts for testing or maintenance purposes. During operation, this lock-down door must always be in the closed position.
- 4 Bipolar LED (depending on version) indicating the relay status.
- 5 Removable ID tag for relay identification.
- 6 Four notches for DIN rail mounting adapter or panel mounting adapter with fixing lugs.
- 7 Five, eight, eleven or fourteen quick-connect pins.
- 8 Area by which the product can be easily gripped.
- 9 Mounting adapter enabling direct mounting of the relay on a panel.
- 10 Mounting adapter enabling direct mounting of the relay on a DIN rail.

### Socket description

#### Sockets with mixed contact terminals (1)

- 1 Connection by screw clamp terminals.
- 2 Five, eight, eleven or fourteen female contacts for the relay pins.
- 3 Location for protection modules or the timer module.
- 4 Locating slot for mounting on DIN rail with mounting clip.
- 5 Two or four mounting holes for panel mounting.

(1) The inputs are mixed with the relay coil terminals, with the outputs being located on the opposite side of the socket.

## General characteristics

<b>Conforming to standards</b>			IEC/EN 61810-1 (iss. 2), UL 508, CSA C22-2 n° 14
<b>Product certifications</b>			cULus File E164862 CCN NLDX, NLDX7; cURus File E164862 CCN NLDX2, NLDX8; CSA; CE; RoHS compliant
<b>Ambient air temperature</b> around the device	Storage	°C (F)	-40... +85 (-40... +185)
	Operation	°C (F)	-40... +55 (-40... +131)
<b>Vibration resistance</b> conforming to IEC/EN 60068-2-6	In operation		3 gn (10...150 Hz/± 1 mm / 5g/5 cycles)
	Not operating		5 gn (10...150 Hz/± 1 mm / 5g/5 cycles)
<b>Degree of protection</b>			IP 40
<b>Shock resistance</b> conforming to IEC/EN 60068-2-27	Opening		15 gn
	Closing		15 gn
<b>Protection category</b>			RT I
<b>Mounting position</b>			Any

## Insulation characteristics

<b>Rated insulation voltage (Ui)</b>	Conforming to IEC/EN 60947	V	250 (IEC), 300 (UL, CSA)
<b>Rated impulse withstand voltage (Uimp)</b>		kV	4 (1.2/50 μs)
<b>Dielectric strength</b> (rms voltage)	Between coil and contact	~ V	1550
	Between poles	~ V	1550
	Between contacts	~ V	1500

## Contact characteristics

Relay type			RPM1●●●	RPM2●●●	RPM3●●●	RPM4●●●
<b>Number and type of contacts</b>			1 C/O	2 C/O	3 C/O	4 C/O
<b>Contact materials</b>			AgNi			
<b>Conventional thermal current (Ith)</b>	For ambient temperature ≤ 55 °C	A	15			
<b>Rated operational current</b> in utilization categories AC-1 and DC-1	Conforming to IEC	NO	A	15		
		NC	A	7.5		
	Conforming to UL		A	15		
<b>Switching current</b>	Minimum	mA	10			
<b>Switching voltage</b>	Maximum	V	~ 250 (IEC)			
	Minimum	V	17			
<b>Nominal load (resistive)</b>		A	15 / 250 ~ V			
		A	15 / 28 ~ V			
<b>Switching capacity</b>	Maximum	~	VA	3750		
		⋮	W	420		
	Minimum	mW	170			
<b>Maximum operating rate</b> In operating cycles/hour	No-load		18 000			
	Under load		1200			
<b>Utilization coefficient</b>			20 %			
<b>Mechanical durability</b>	In millions of operating cycles		10			
<b>Electrical durability</b> In millions of operating cycles	Resistive load		0.1			0.06
	Inductive load		See curves below			

**Electrical durability of contacts**  
Resistive load ~

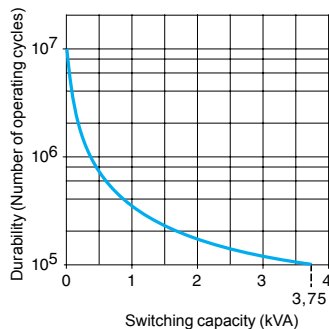

Reduction coefficient for inductive load ~  
(depending on power factor cos φ)

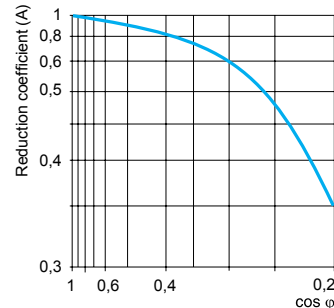

Maximum switching capacity on resistive load ⋮

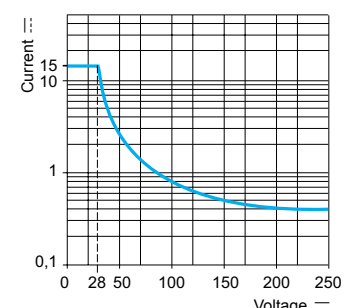

Inductive load durability = resistive load durability x reduction coefficient.

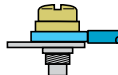
Coil characteristics				RPM1●●●	RPM2●●●	RPM3●●●	RPM4●●●			
Relay type										
Average consumption		~	VA	0.9	1.2	1.5	1.5			
		≡	W	0.7	0.9	1.7	2			
Drop-out voltage threshold		~		≥ 0.15 U <sub>c</sub>						
		≡		≥ 0.1 U <sub>c</sub>						
Operating time (response time)	Between coil energization and making of the NO contact	~	ms	20	25	25	20			
		≡	ms	20	25	25	20			
	Between coil de-energization and making of the NC contact	~	ms	20						
		≡	ms	20						
Control circuit voltage U <sub>c</sub>			V	12	24	48	110	120	230	
Relay control voltage codes				JD	BD	ED	FD	–	–	
d.c. supply	Average resistance at 20 °C ± 10%	RPM1●●●	Ω	180	750	2600	13 100	–	–	
		RPM2●●●	Ω	160	650	2600	11 000	–	–	
		RPM3●●●	Ω	100	400	2600	8600	–	–	
		RPM4●●●	Ω	96	388	1550	7340	–	–	
	Operating voltage limits	Min.	V	9.6	19.2	38.4	88	–	–	
		Max.	V	13.2	26.4	52.8	121	–	–	
	Relay control voltage codes				–	B7	E7	–	F7	P7
	a.c. supply	Average resistance at 20 °C ± 15%	RPM1●●●	Ω	–	160	720	–	4430	15 720
RPM2●●●			Ω	–	180	770	–	4430	15 000	
RPM3●●●			Ω	–	103	770	–	2770	12 000	
RPM4●●●			Ω	–	84.3	338	–	2220	9120	
Operating voltage limits		Min.	V	–	19.2	38.4	–	96	184	
		Max.	V	–	26.4	52.8	–	132	253	
Socket characteristics				RPZF1	RPZF2	RPZF3	RPZF4			
Socket type				RPM1●●●	RPM2●●●	RPM3●●●	RPM4●●●			
Relay types used				RXM02●●●	RXM04●●●	RUX24●●●	RUX24●●●			
Protection module types used				RXM02●●●	RXM04●●●	RUX24●●●	RUX24●●●			
Contact terminal arrangement				Mixed						
Wire connection method				Screw clamp terminals						
Product certifications				cURus File E172326 CCN SWIV2, SWIV8; CSA; CE; RoHS compliant						
Conforming to standards				IEC 61984, CE						
Electrical characteristics										
Conventional thermal current (I <sub>th</sub> )		A		16						
Maximum operating voltage		V		250 (IEC)						
Insulation characteristics										
Between adjacent output contacts		V <sub>rms</sub>		2500						
Between input and output contacts		V <sub>rms</sub>		2500						
Between contacts and DIN rail		V <sub>rms</sub>		2500						
General characteristics										
Ambient air temperature around the device	Operation	°C		- 40...+ 55						
	Storage	°C		- 40...+ 85						
Degree of protection		Conforming to IEC/EN 60529		IP 20						
Connection	Solid wire	1 conductor		0.5...1.5 mm <sup>2</sup> - AWG 20...AWG 16	0.5...2.5 mm <sup>2</sup> - AWG 20...AWG 14					
		2 conductors		0.5...1.5 mm <sup>2</sup> - AWG 20...AWG 16	0.5...2.5 mm <sup>2</sup> - AWG 20...AWG 14					
	Flexible wire with cable end	1 conductor		0.25...1 mm <sup>2</sup> - AWG 22...AWG 17	0.25...1.5 mm <sup>2</sup> - AWG 22...AWG 16					
		2 conductors		0.25...1 mm <sup>2</sup> - AWG 22...AWG 17	0.25...1.5 mm <sup>2</sup> - AWG 22...AWG 16					
Maximum tightening torque / Screw size		Nm		1 / M3 screw	1 / M3.5 screw					
Mounting				35 mm DIN rail / panel mount						
Mounting on DIN rail				By red plastic clip						
Terminal referencing				IEC, NEMA						
Compatibility with the metal hold-down clip				Yes	No					
Timer module compatibility				No			Yes			
Protection module				RXM040W, RXM041●●, RXM021●●		RUW24●●				
Clip-in ID tags				No						
Wire connection method	Screw clamp terminals									



RPM41BD

Power relays without LED (sold in lots of 10)								
Control circuit voltage	Number and type of contacts - Thermal current (Ith)							
	1 C/O - 15 A		2 C/O - 15 A		3 C/O - 15 A		4 C/O - 15 A	
	Catalog number	Weight	Catalog number	Weight	Catalog number	Weight	Catalog number	Weight
V		kg		kg		kg		kg
⎓ 12	RPM11JD	0.026	RPM21JD	0.036	RPM31JD	0.054	RPM41JD	0.071
⎓ 24	RPM11BD	0.026	RPM21BD	0.036	RPM31BD	0.054	RPM41BD	0.071
⎓ 48	RPM11ED	0.026	RPM21ED	0.036	RPM31ED	0.054	RPM41ED	0.071
⎓ 110	RPM11FD	0.026	RPM21FD	0.036	RPM31FD	0.054	RPM41FD	0.071
~ 24	RPM11B7	0.026	RPM21B7	0.036	RPM31B7	0.054	RPM41B7	0.071
~ 48	RPM11E7	0.026	RPM21E7	0.036	RPM31E7	0.054	RPM41E7	0.071
~ 120	RPM11F7	0.026	RPM21F7	0.036	RPM31F7	0.054	RPM41F7	0.071
~ 230	RPM11P7	0.026	RPM21P7	0.036	RPM31P7	0.054	RPM41P7	0.071



RPM42BD

Power relays with LED (sold in lots of 10)								
Control circuit voltage	Number and type of contacts - Thermal current (Ith)							
	1 C/O - 15 A		2 C/O - 15 A		3 C/O - 15 A		4 C/O - 15 A	
	Catalog number	Weight	Catalog number	Weight	Catalog number	Weight	Catalog number	Weight
V		kg		kg		kg		kg
⎓ 12	RPM12JD	0.026	RPM22JD	0.036	RPM32JD	0.054	RPM42JD	0.071
⎓ 24	RPM12BD	0.026	RPM22BD	0.036	RPM32BD	0.054	RPM42BD	0.071
⎓ 48	RPM12ED	0.026	RPM22ED	0.036	RPM32ED	0.054	RPM42ED	0.071
⎓ 110	RPM12FD	0.026	RPM22FD	0.036	RPM32FD	0.054	RPM42FD	0.071
~ 24	RPM12B7	0.026	RPM22B7	0.036	RPM32B7	0.054	RPM42B7	0.071
~ 48	RPM12E7	0.026	RPM22E7	0.036	RPM32E7	0.054	RPM42E7	0.071
~ 120	RPM12F7	0.026	RPM22F7	0.036	RPM32F7	0.054	RPM42F7	0.071
~ 230	RPM12P7	0.026	RPM22P7	0.036	RPM32P7	0.054	RPM42P7	0.071



RPZF2 + relay RPM22F7



RUW24...



RPZ1DA



RPZ3FA

Sockets					
Contact terminal arrangement	Connection	Relay type	Sold in lots of	Catalog number	Weight kg
Mixed	Screw clamp terminals	RPM1●●●	10	RPZF1	0.042
		RPM2●●●	10	RPZF2	0.054
		RPM3●●●	10	RPZF3	0.072
		RPM4●●●	10	RPZF4	0.094

Protection modules					
Description	Voltage	Socket type	Sold in lots of	Catalog number	Weight kg
<b>V</b>					
Diode	--- 6...250	RPZF1RPZ F2	20	RXM040W	0.003
		RPZF3 RPZF4	10	RUW240BD	0.004
RC circuit	~ 24...60	RPZF1RPZ F2	20	RXM041BN7	0.010
	~ 110...240	RPZF1RPZ F2	20	RXM041FU7	0.010
Varistor	~--- 6...24	RPZF1RPZ F2	20	RXM021RB	0.030
	~--- 24...60	RPZF1RPZ F2	20	RXM021BN	0.030
	~--- 110...240	RPZF1RPZ F2	20	RXM021FP	0.030
	~--- 24	RPZF3 RPZF4	10	RUW242B7	0.004
	~--- 240	RPZF3 RPZF4	10	RUW242P7	0.004

Timer module (1)					
Description	Voltage	Socket type		Catalog number	Weight kg
<b>V</b>					
Multifunction	~--- 24... 240	RPZF3 RPZF4		RUW101MW	0.020

Accessories					
Description		For use with	Sold in lots of	Catalog number	Weight kg
Metal hold-down clip (for single-pole relays)		RPZF1	20	RPZR235	0.001
Mounting adapters for DIN rail (2)		RPM1●●●	20	RPZ1DA	0.004
		RPM2●●●	20	RXE2DA	0.004
		RPM3●●●	20	RPZ3DA	0.004
		RPM4●●●	20	RPZ4DA	0.006
Mounting adapters with fixing lugs for panel		RPM1●●●	20	RPZ1FA	0.002
		RPM2●●●	20	RXE2FA	0.002
		RPM3●●●	20	RPZ3FA	0.003
		RPM4●●●	20	RPZ4FA	0.004
Clip-in ID tags (sheet of 108 ID tags)		All relays	10	RXZL520	0.080

(1) See timer module description (selection of functions and time delays) on page 41

(2) Test button becomes inaccessible.

**Dimensions (mm):**

**Power relays**

**RPM 1**

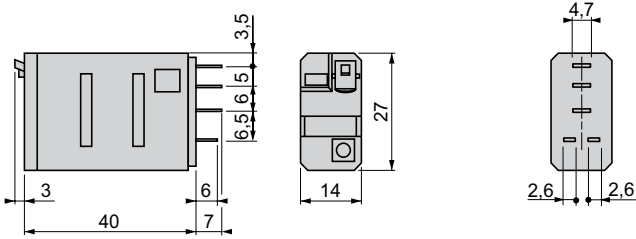

**Common side view**

**RPM2**

**RPM 3**

**RPM 4**

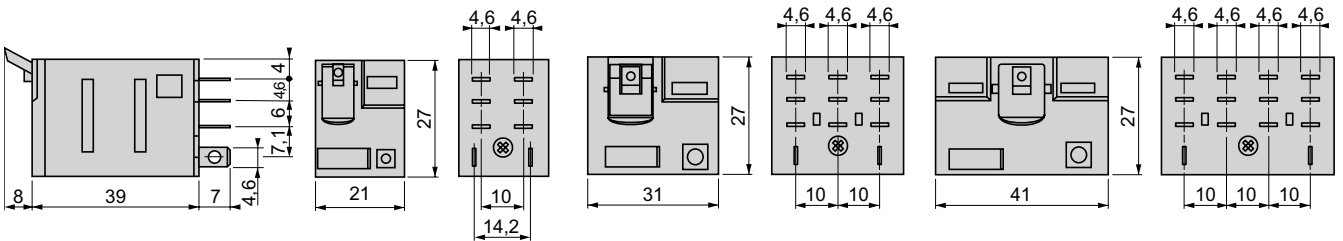

**Sockets**

**RPZF1**

**RPZF2**

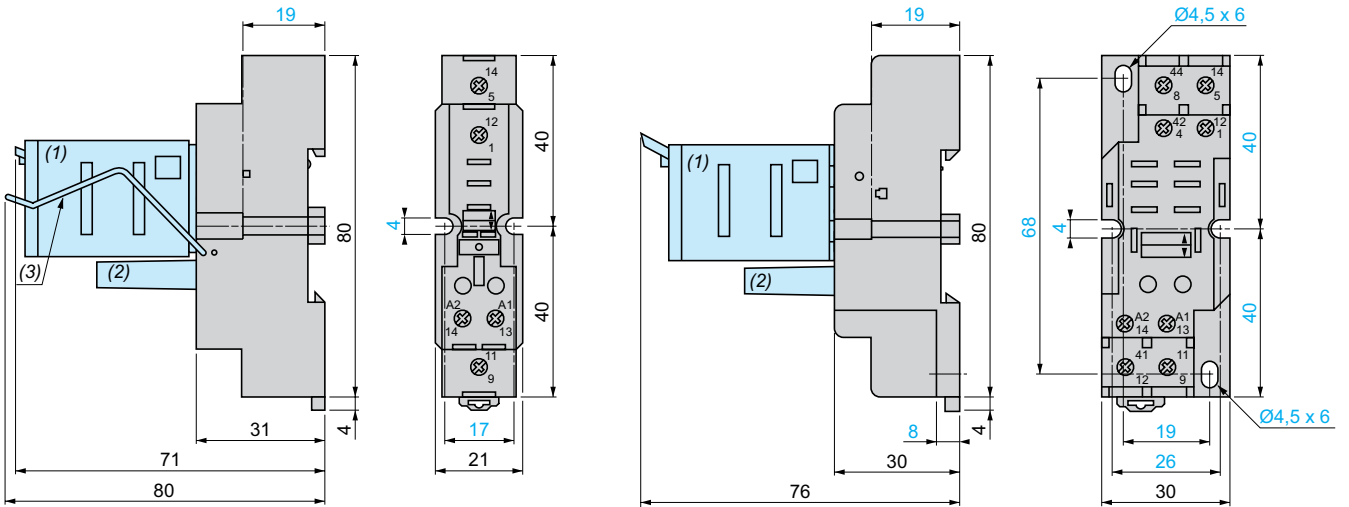

**Common side view**

**RPZF3**

**RPZF4**

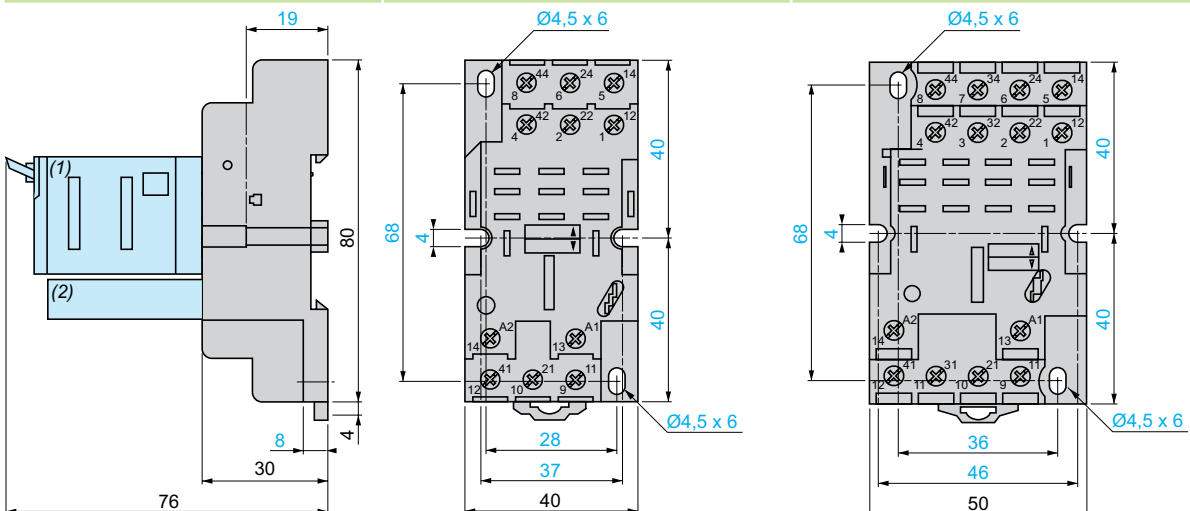

- (1) Relays
- (2) Protection module
- (3) Retention clip

**Dimensions (mm):**

**Mounting adapters for DIN rail**

**RPZ1DA**

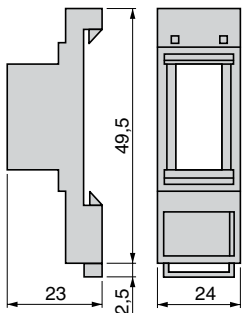

**RXZE2DA**

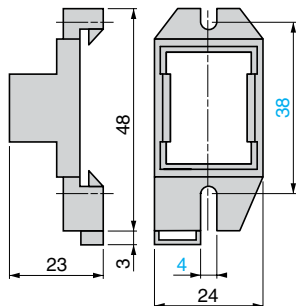

**RPZ3DA**

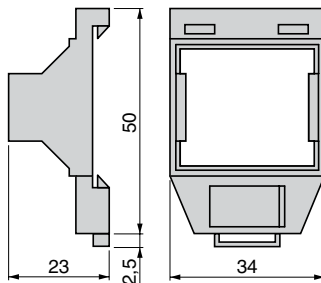

**RPZ4DA**

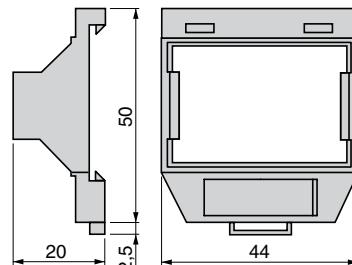

**Mounting adapters with fixing lugs for panel**

**RPZ1FA**

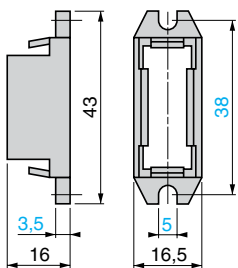

**RXZE2FA**

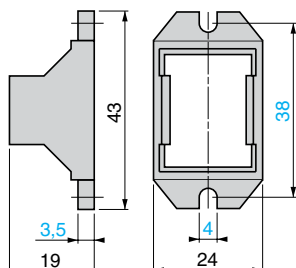

**RPZ3FA**

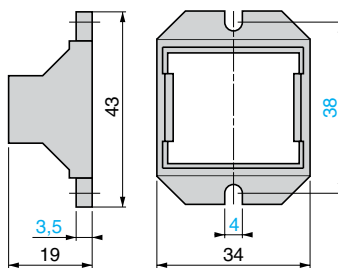

**RPZ4FA**

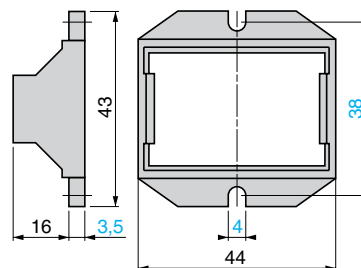

**Mounting**

**Mounting adapters for DIN rail (1)**

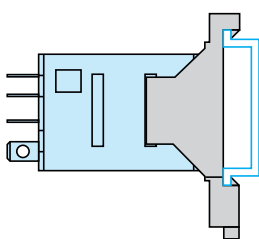

**Mounting adapters with fixing lugs for panel**

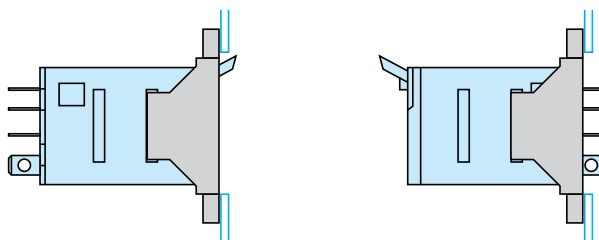

(1) Test button becomes inaccessible



### Wiring diagrams

#### Power relays

##### RPM1●●●

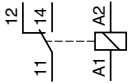

##### RPM2●●●

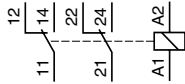

##### RPM3●●●

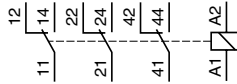

##### RPM4●●●

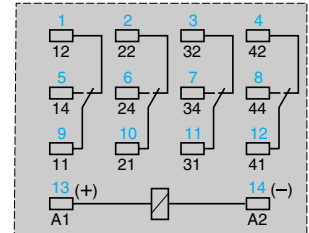
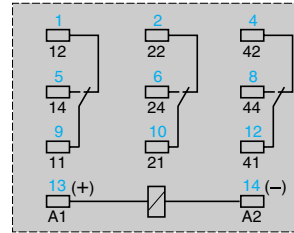
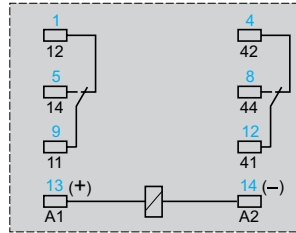
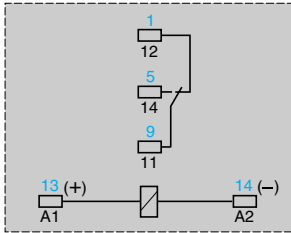
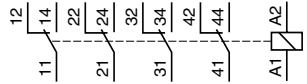

Symbols shown in blue correspond to Nema marking.

#### Sockets

##### RPZF1

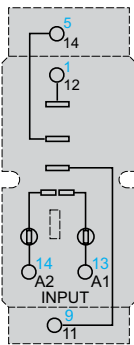

##### RPZF2

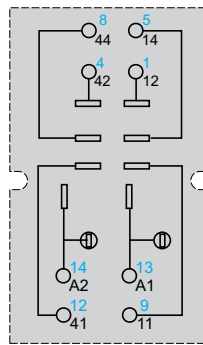

##### RPZF3

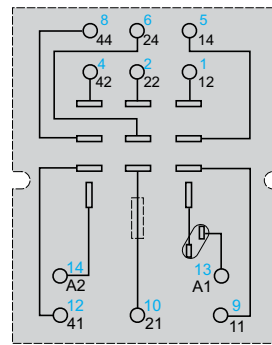

##### RPZF4

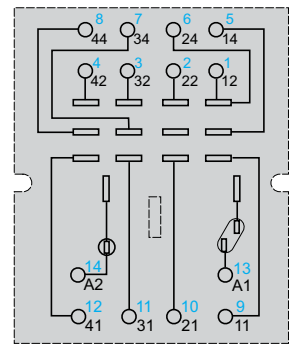

Symbols shown in blue correspond to Nema marking.

#### Protection modules

##### RXM040W, RUW240BD

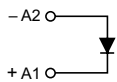

##### RXM041●●●, RUW241P7

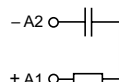

##### RXM021●●●, RUW242●●

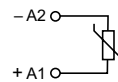

## Introduction of the product range

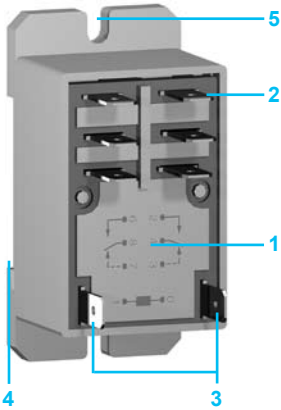

- 1 30 A relays with 2 C/O or 2 N/O contacts
- 2 Four or six quick-connect terminals
- 3 Two relay coil terminals
- 4 A locating slot for DIN rail mounting
- 5 Two holes for panel mounting

## General characteristics

<b>Conforming to standards</b>			IEC/EN 61810-1 (issue 2), UL 508, CSA C22-2 n°14
<b>Product certifications</b>			UL, CSA
<b>Ambient air temperature</b> around the device	Storage	°C (°F)	- 40...+ 85 (-40... +185)
	Operation	°C (°F)	- 40...+ 55 (-40... + 131)
<b>Vibration resistance</b> conforming to EC/EN 60068-2-6	In operation		3 gn (10...150 Hz / ± 1 mm/5 g/5 cycles)
	Not operating		10 gn (10...150 Hz / ± 1 mm/5 g/5 cycles)
<b>Degree of protection</b>	Conforming to IEC/EN 60529		IP 40
<b>Shock resistance</b> conforming to IEC/EN 60068-2-27	Opening		10 gn
	Closing		10 gn
<b>Protection category</b>			RT IV
<b>Mounting position</b>			Any

## Insulation characteristics

<b>Rated insulation voltage (Ui)</b>	Conforming to IEC/EN 60947	<b>V</b>	250
<b>Rated impulse withstand voltage (Uimp)</b>		<b>kV</b>	4 (1,2/50 μs)
<b>Dielectric strength</b> (rms voltage)	Between coil and contact	<b>~ V</b>	1550
	Between poles	<b>~ V</b>	1550
	Between contacts	<b>~ V</b>	1500

### Contact characteristics

Relay type		RPF 2A●●		RPF 2B●●	
<b>Number and type of contacts</b>				2 N/O	
<b>Contact materials</b>				AgSnO <sub>2</sub>	
<b>Conventional thermal current (I<sub>th</sub>)</b>	For ambient temperature ≤ 40°C	<b>A</b>	30 (when mounted with 13 mm gap between two relays) 25 (when mounted side by side without a gap)		
<b>Rated operational current in utilisation category AC-1</b>	Conforming to IEC	"C"	<b>A</b>	30	
		"O"	<b>A</b>	3	
	Conforming to UL		<b>A</b>	30	
<b>Switching current</b>	Minimum	<b>mA</b>	10		
<b>Switching voltage</b>	Maximum	<b>V</b>	~/∞ 250 (IEC)		
	Minimum	<b>V</b>	∞ 17		
<b>Nominal load (resistive)</b>		30 A / 250 ~ V - 30 A / 28 ∞ V (when mounted with 13 mm gap between two relays) 25 A / 250 ~ V - 25 A / 28 ∞ V (when mounted side by side without a gap)			
<b>Switching capacity</b>	Maximum	7500 ~ VA / 840 W (when mounted with 13 mm gap between two relays) 6250 ~ VA / 700 W (when mounted side by side without a gap)			
	Minimum	<b>mW</b>	170		
<b>Maximum operating rate</b> In operating cycles/hour	No load	18 000			
	Under load	1200			
<b>Utilization coefficient</b>		10 %			
<b>Mechanical durability</b>	In millions of operating cycles	5			
<b>Electrical durability</b> In millions of operating cycles	Resistive load	0.05 (N/O contact only)			
	Inductive load	See curves below			

**Electrical durability of contacts**  
Resistive load ~

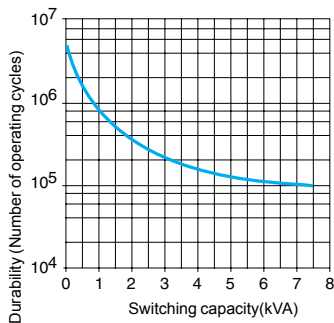

Reduction coefficient for inductive load ~  
(depending on power factor cos φ)

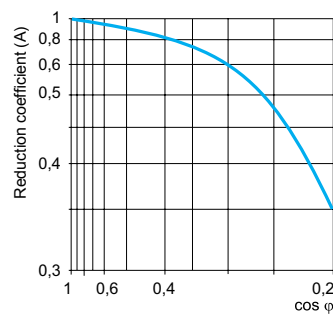

Maximum switching capacity on resistive load ∞

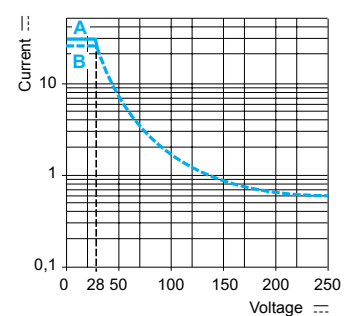

Durability (inductive load) = durability (resistive load) x reduction coefficient.

**A** RPF 2●●●: 30 A  
**B** RPF 2●●●: 25 A

### Coil characteristics

<b>Average consumption</b>		~	<b>VA</b>	4				
		∞	<b>W</b>	1.7				
<b>Drop-out voltage threshold</b>		~		≥ 0.15 U <sub>c</sub>				
		∞		≥ 0.1 U <sub>c</sub>				
<b>Operating time</b> (response time)	Between coil energization and making of the On-delay contact	~	<b>ms</b>	20				
		∞	<b>ms</b>	20				
	Between coil de-energization and making of the Off-delay contact	~	<b>ms</b>	20				
		∞	<b>ms</b>	20				
<b>Control circuit voltage U<sub>c</sub></b>		<b>V</b>	<b>12</b>	<b>24</b>	<b>110</b>	<b>120</b>	<b>230</b>	
<b>Relay control voltage codes</b>			<b>JD</b>	<b>BD</b>	<b>FD</b>	–	–	
<b>DC supply</b>	Average resistance at 20 °C ± 10%	Ω	86	350	7255	–	–	
	Operating voltage limits	Min.	<b>V</b>	9.6	19.2	88	–	–
		Max.	<b>V</b>	13.2	26.4	121	–	–
<b>Relay control voltage codes</b>			–	<b>B7</b>	–	<b>F7</b>	<b>P7</b>	
<b>AC supply</b>	Average resistance at 20 °C ± 15%	Ω	–	250	–	3200	13 000	
	Operating voltage limits	Min.	<b>V</b>	–	19.2	–	96	184
		Max.	<b>V</b>	–	26.4	–	132	253

# Zelio® Plug-In Relays

## RPF power relays



RPF 2B●●

Power relays(sold in lots of 10)			
Control circuit voltage	Number and type of contacts - Thermal current (Ith)		Weight
	2 N/O - 30 A (1)	2 C/O - 30 A (1)	
	Catalog number	Catalog number	
<b>V</b>			<b>kg</b>
≡ 12	RPF2AJD	RPF2BJD	0.082
≡ 24	RPF2ABD	RPF2BBD	0.082
≡ 110	RPF2AFD	RPF2BFD	0.082
~ 24	RPF2AB7	RPF2BB7	0.082
~ 120	RPF2AF7	RPF2BF7	0.082
~ 230	RPF2AP7	RPF2BP7	0.082

(1) 30 A when mounted with 13 mm gap between two relays and 25 A when mounted side by side without a gap.

**Dimensions**

**Power relays**

RPF 2A●●, RPF 2B●●

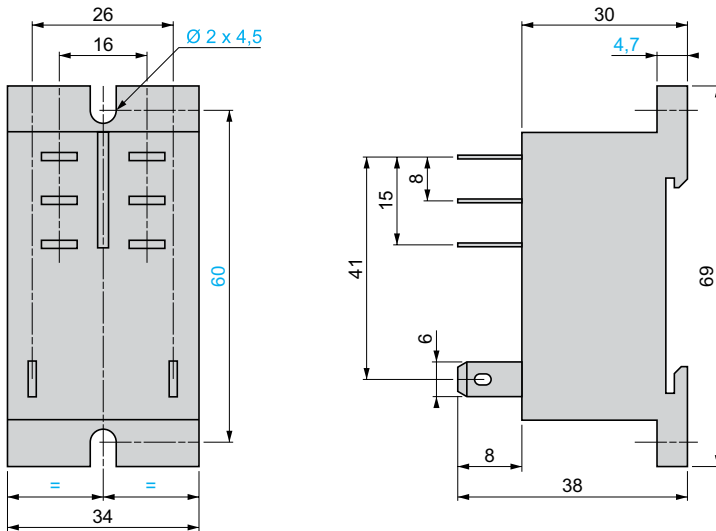

**Schemes**

**Power relays**

RPF 2A●●

RPF 2B●●

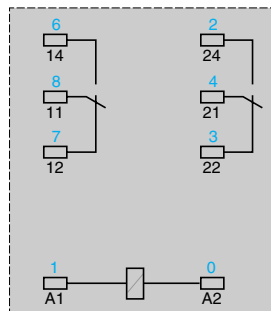
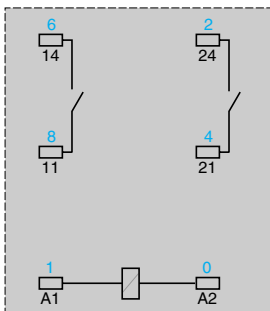

Symbols shown in blue correspond to Nema marking.

**Applications**

**Electromechanical interface modules**



**Functions**

Input

**Width (mm)**

17.5	9.5
------	-----

**Contact arrangement**

1 N/O 2 N/O 1 C/O	1 N/O
-------------------------	-------

**Thermal current**

–

**Control voltages**

$\overline{\sim}$ 110...127 V $\sim$ 24 V, 48 V $\sim$ 115...127 V $\sim$ 230/240 V	$\overline{\sim}$ 24 V, 48 V $\sim$ 115...127/50 Hz $\sim$ 115...127/60 Hz $\sim$ 230...240/50-60 Hz
--	---

**Indication**

Mechanical for contacts and/or LED for control	LED for control
--	-----------------

**Product numbers**

<b>ABR1E</b>	<b>ABR2E</b>
--------------	--------------

**Pages**

56	62
----	----

Solid state interface modules



Output		Input and output Very low level switching		Input	Output
17.5	12	17.5	9.5	9.5/17.5	
1 N/O 2 N/O 1 C/O 1 N/C + 1 N/O	1 N/O	1 C/O	-		
12 A	5 A	-		5 A	
⎓ 24 V ~ 24 V, 48 V ~ 115...127 V ~ 110 V	⎓ 24 V		⎓ 5, 24, 48 V ~ 115...127/50 Hz ~ 120...127/60 Hz ~ 230...240/50 Hz ~ 230...240/60 Hz	⎓ 24 V	
Mechanical for contacts and/or LED for control	LED for control				
<b>ABR1S</b>	<b>ABR2S</b>	<b>ABR2•B312B</b>	<b>ABS2E</b>	<b>ABS2S</b>	
56	62	62	68		

# Interfaces

## For discrete signals

### Electromechanical interface modules

ABR-1 electromechanical interface modules are supplied in the form of compact modules, 17.5 mm wide.

They are designed for interfacing discrete digital control signals exchanged within an automated system between the processing unit (PLC, numerical controller, etc) and the other components (contactors, solenoid valves, indicator lamps, proximity sensors, etc).

These products are based on advanced contactor technology and are easily adapted to industrial environments. They conform to the most recent IEC 947-5-1 standards.

#### Composition

The ABR-1 range includes 2 families:

##### Input interfaces

Input interfaces are designed for switching input signals to the processor and are characterized by their advanced contact reliability: less than 1 interruption per 100 million operating cycles at  $\approx 17\text{ V}, 5\text{ mA}$ .

The switching level is sufficiently high to help ensure that the interfaces can directly control most contactors and indicator lamps.

##### Output interfaces

Output interfaces are designed for the control of preactuators (contactors, solenoid valves, etc) for signalling devices (indicators lamps, audible warnings, etc). They are characterized by a high switching capacity and an average durability 5 times greater than that of traditional interface modules, which incorporate standard relays.

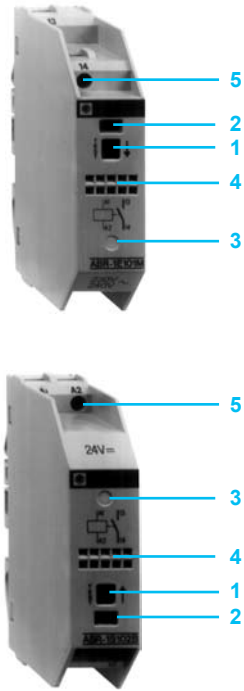

- 1 Override contacts by pressing button (not holding it down) for a simple and quick test during installation or maintenance operations on the installation
- 2 Green indicator showing the mechanical position of the contacts
- 3 LED indicating the control signal state
- 4 Channel identification : 5 individual characters for AB1-R/G or one AB1-SA2 marker tag
- 5 Connection by screw clamp terminal enabling easy attachment of 2 wires per terminal. The layout of the connection terminals for both families (input and output) is designed for rational wiring and a clear separation between the incoming (processing) and outgoing (power and process control) circuits.



## Examples of applications with PLCs

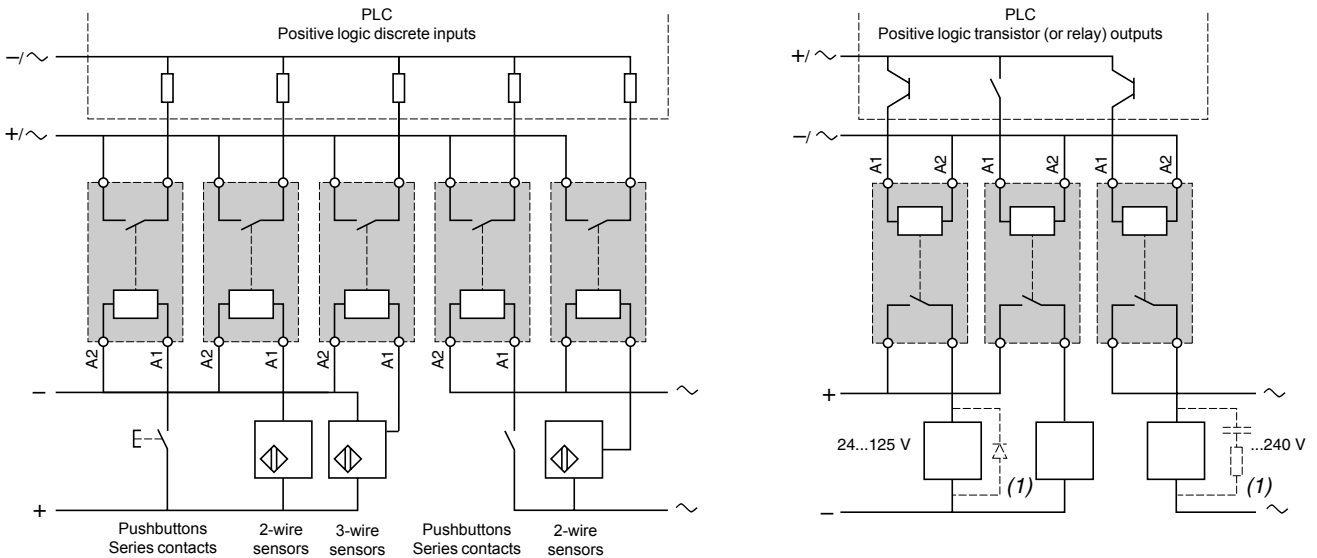

(1) Essential on inductive loads (can be replaced with peak limiter ).

## Environment

<b>Conforming to standards</b>				IEC 60947-1, UL 508, CSA C22.2 No. 14	
<b>Product certifications</b>				UL, CSA, BV, LROS, DNV	
<b>Degree of protection</b>	Conforming to IEC 529 (protection against direct contact)			IP 00	
<b>Protective treatment</b>				"TC"	
<b>Flame resistance</b>	Conforming to IEC 695-2-1	Incandescent wire	°C	850	
		Conforming to UL 94		V0	
<b>Shock resistance</b>	Conforming to IEC 68-2-27	Semi-sinusoidal waves 11 ms		50 gn	
<b>Vibration resistance</b>	Conforming to IEC 68-2-6	10...55 Hz		6 gn	
<b>Resistance to electrostatic charges</b>	Conforming to IEC 801-2	Level 3	kV	8	
<b>Resistance to rapid transients</b>	Conforming to IEC 801-4	On power supply	kV	2	
		On I/O	kV	1	
<b>Resistance to shock waves</b>	Conforming to IEC 255-4	Waveform 1.2/50 ms ; 0.5 J	U ≤ 50 V	kV	0.5
			U > 50 V	kV	2.5
<b>Cross-sections which may be connected</b>	Flexible wire with no cable end	1 or 2-wire	mm <sup>2</sup>	0.6...2.5	
	Flexible wire with cable end	1 or 2-wire	mm <sup>2</sup>	0.34...2.5	
	Rigid cable	1-wire	mm <sup>2</sup>	0.27...4	
2-wire		mm <sup>2</sup>	0.27...2.5		
<b>Operating position</b>				Any	
<b>Ambient air temperature around the device</b>	Unrestricted operation		°C	-5...+40	
	Permissible at Un		°C	-20...+60	
	Storage		°C	-40...+70	
<b>Operating altitude</b>				m	≤ 3000
<b>Installation category</b>	Conforming to IEC 947-1			II	
<b>Degree of pollution</b>	Conforming to IEC 947-5-1			3	
<b>Mounting</b>				Standard DIN rails	

Control circuit characteristics (40°C ambient temperature)										
Type of interface		ABR 1S●02B	ABR 1●●●8B	ABR 1●●●8E	ABR 1E●12F	ABR 1●●●1F	ABR 1E●11M	ABR 1E●01M		
Rated voltage (Uc)	V	--- 24	~ 24	~ 48	--- 110...127	~ 115...127	~ 230...240	~ 230...240		
Current frequency	Hz	–	50/60	50/60	–	50/60	50/60	50/60		
Energization threshold (at ± 5 %)	V	15	16.5	34	75	86	170	164		
Maximum operating voltage	--- / ~	30	30	53	140	140	264	264		
Maximum drop-out (at ± 5 %) voltage (Uo)	--- / ~	3.2	3.8	8.5	16	34	68	78		
Maximum current (Un)	--- / ~	62	62/55	36/32	15	8	7	5.5		
Minimum holding current	--- / ~	6.6	4.9/5.2	4.7/5.4	1.5	2.4	2	1.5		
Maximum dissipated power	50 Hz/60 Hz	W	1.5	1.5	1.5	1.5	1.5	1.5		
Disappearance of voltage maximum time up to which contact is maintained	ms	3	8	10	10	6	5	6		
Display of control circuit by LED		No	Yes	Yes	Yes	Yes	Yes	No		
Built-in protection reversed polarity		Yes	Yes	Yes	Yes	–	–	–		
Contact characteristics										
Type of interface		ABR1E●●●●			ABR1S●●●●					
Maximum switching voltage	~ V	252				252				
	--- V	125				125				
Maximum rated operating voltage Ue	Conforming to IEC 947-5-1	~ V	230			230				
		--- V	125			125				
Operating current frequency		Hz	50/60			50/60				
Thermal current Ith	Conforming to IEC 947-1	A	2			12				
Rated operating current (Ie) per 1 million operating cycles	Conforming to IEC 947-5-1 Ue : ~ 230 V	AC12	A	2			4			
		AC13	A	1			1			
		AC14	A	1			1			
	Conforming to IEC 947-5-1 Ue : --- 24 V	AC15	A	1			1			
		DC12	A	2			5			
		DC13	A	1			1			
Minimum switching capacity		mA	3			3				
Minimum switching voltage		V	17			17				
Protection against short-circuits	For I <sub>k</sub> ≤ 2.5 kA (~) and ≤ 100 A (---) Type and value of recommended fuse	A	gG/gF : 16			gG/gF : 16				
Low power switching performance of contacts (17 V - 5 mA)	Number of interruptions per "n" million operating cycles		10 <sup>-8</sup>			10 <sup>-8</sup>				
Other characteristics										
Operating time at Un and at 20 °C	Between energization of coil and closing of N/O contact	ms	≤ 12							
	Between energization of coil and opening of N/C contact	ms	≤ 12							
	Between de-energization of coil and opening of N/O contact	ms	≤ 12							
	Between de-energization of coil and closing of N/C contact	ms	≤ 12							
Duration of bounce		ms	≤ 3							
Contact bridging times between contact "N/C" and "N/O"	Maximum make before break or break before make time	ms	1							
Maximum operating rate	At no-load	Hz	6							
	At Ie	Hz	0.5							
Mechanical durability in millions of operating cycles	ABR-1 (1 N/O or 2 N/O)		≥ 20 million							
	ABR-1 (1 C/O or 1 N/C + 1 N/O)		≥ 10 million							
Rated isolation voltage	Conforming to IEC 947-1	V	250							
	Conforming to VDE 0110 group C	V	250							
Insulation test voltage for 1 min.	Between coil circuit and contact circuits	kV	4							
	Between wired interface and ground	kV	2.5							
	Between independent contacts	kV	1.5							

#### Electrical durability of contacts

Test conditions : in accordance with standard IEC 947-5-1 set up for rated control voltage, operating rate : 1800 cycles/hour. (0.5 Hz).

#### a.c. loads

Operating cycles in millions

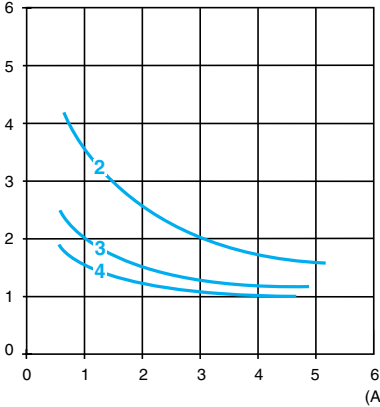

AC-12 : control of resistive loads and isolated solid state loads via optocoupler  
 $\cos \varphi \geq 0.9$

Operating cycles in millions

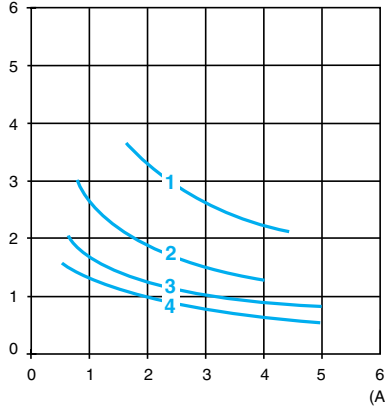

AC-13 : control of isolated solid state loads via transformer  
 $\cos \varphi \geq 0.65$

Operating cycles in millions

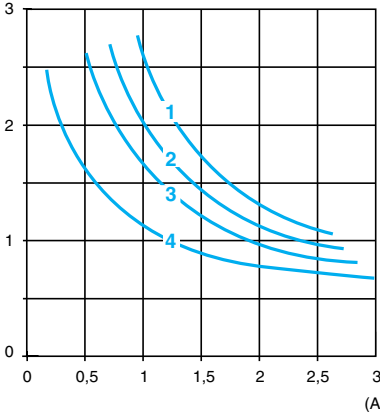

AC-14 : control of weak electromagnetic loads of electromagnets  $\leq 72 \text{ VA}$   
 make:  $\cos \varphi = 0.3$   
 break:  $\cos \varphi = 0.3$   
 AC-15 : control of electromagnetic loads of electromagnets  $> 72 \text{ VA}$   
 make:  $\cos \varphi = 0.7$   
 break:  $\cos \varphi = 0.4$

- 1 24 V
- 2 48 V
- 3 127 V
- 4 230 V

#### d.c. loads

Operating cycles in millions

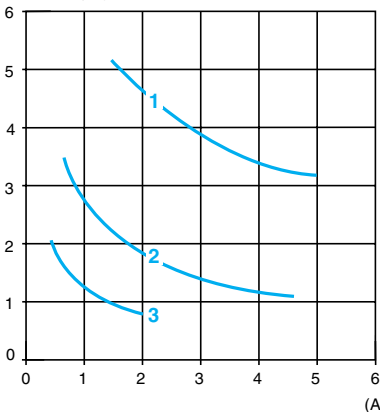

DC-12 : control of resistive loads and isolated solid state loads via optocoupler  
 $L/R \leq 1 \text{ ms}$

Operating cycles in millions

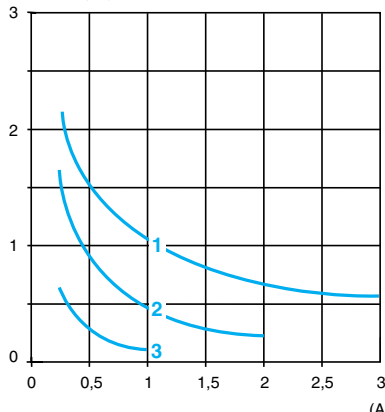

DC-13 : control of electromagnets  
 $L/R \leq 2 \times (U_e \times I_e) \text{ in ms.}$   
 $U_e$ : rated operating voltage  
 $I_e$ : rated operating current

- 1 24 V
- 2 48 V
- 3 127 V

# Interfaces

For discrete signals  
Electromechanical interface modules  
Control circuit: a.c. or d.c.



ABR1E101M



ABR1E318B



ABR1S102B

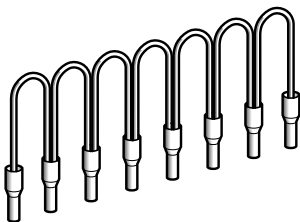

ABFC08R●●●

Input interface modules (1) (17.5 mm pitch)				
Display	Contact Configuration	Control circuit	Catalog number	Weight
				kg
Mechanical (2)	1 N/O	~ 230/240	ABR1E101M	0.090
	1 C/O	~ 230/240	ABR1E301M	0.090
Mechanical (2) + LED (3)	1 N/O	~ 24	ABR1E118B	0.095
		~ 48	ABR1E118E	0.095
		~ 110...127 (4)	ABR1E112F	0.095
		~ 115...127	ABR1E111F	0.095
		~ 230/240	ABR1E111M	0.095
	2 N/O	~ 24	ABR1E418B	0.095
		~ 48	ABR1E418E	0.095
		~ 110...127(4)	ABR1E412F	0.095
		~ 115...127	ABR1E411F	0.095
		~ 230/240	ABR1E411M	0.095
1 C/O	~ 24	ABR1E318B	0.095	
	~ 48	ABR1E318E	0.095	
	~ 110...127(4)	ABR1E312F	0.095	
	~ 115...127	ABR1E311F	0.095	
	~ 230/240	ABR1E311M	0.095	

Output terminals-relays (1) (17.5 mm pitch)				
Display	Contact Configuration	Control circuit	Catalog number	Weight
				kg
Mechanical (2)	1 N/O	~ 24	ABR1S102B	0.090
	2 N/O	~ 24	ABR1S402B	0.090
	1 C/O	~ 24	ABR1S302B	0.090
	1 N/C + 1 N/O	~ 24	ABR1S602B	0.090
Mechanical (2) + LED (3)	1 N/O	~ 24	ABR1S118B	0.095
		~ 48	ABR1S118E	0.095
		~ 115...127	ABR1S111F	0.095
	2 N/O	~ 24	ABR1S418B	0.095
		~ 48	ABR1S418E	0.095
		~ 110	ABR1S411F	0.095
	1 C/O	~ 24	ABR1S318B	0.095
		~ 48	ABR1S318E	0.095
		~ 110	ABR1S311F	0.095
		1 N/C + 1 N/O	~ 24	ABR1S618B
~ 48	ABR1S618E		0.095	
~ 110	ABR1S611F		0.095	

Commoning links					
Description	For common	Color	Distance between wire ends	Catalog number	Weight
					kg
Commoning links in modules 8 x 1 mm <sup>2</sup>	Coil	White	12	ABFC08R12W	0.020
			2	ABFC08R02W	0.010
	~	Red	12	ABFC08R12R	0.020
			2	ABFC08R02R	0.010
	---	Blue	12	ABFC08R12B	0.020
			2	ABFC08R02B	0.010

(1) Connection by screw-clamp.

(2) By green mechanical indicator light for contact(s) activated electrically or mechanically by pressing the test button.

(3) By green LED illuminated when control signal is present.

(4) With polarization (+ on A1, - on A2).

**Dimensions (mm):**

**ABR 1E**

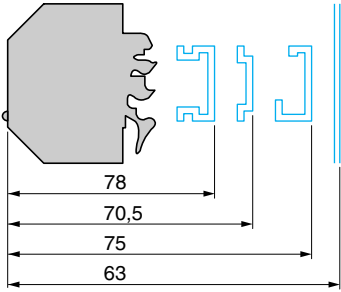

**ABR 1S**

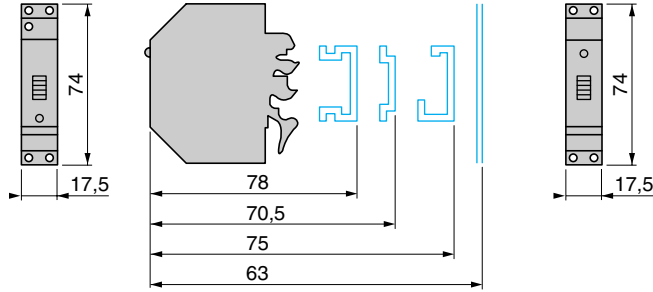

**Wiring diagrams**

**~ 24 V or ~ 230 V interfaces with mechanical indication**

**1 N/O**

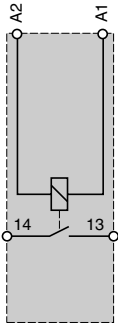

**1 C/O**

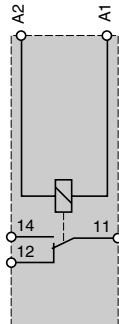

**2 N/O**

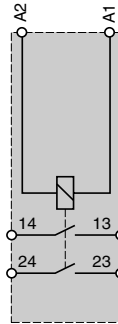

**1 N/C + 1 N/O**

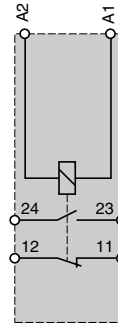

**~ 24 V or ~ 48 V interfaces with mechanical indication + LED**

**1 N/O**

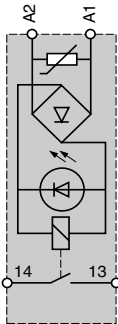

**1 C/O**

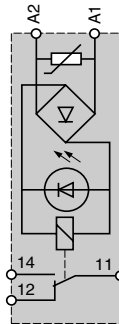

**2 N/O**

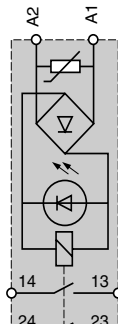

**1 N/C + 1 N/O**

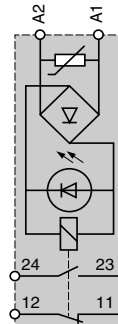

**~ / ~ 110 V or ~ 230 V interfaces with mechanical indication + LED**

**1 N/O**

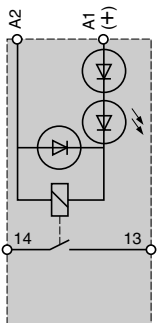

**1 C/O**

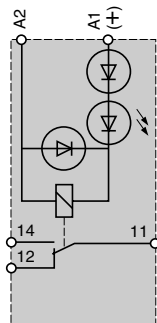

**2 N/O**

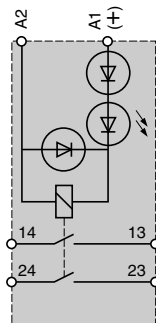

**1 N/C + 1 N/O**

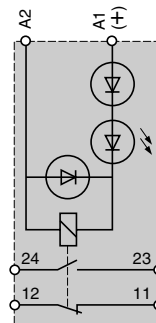

# Interfaces

## For discrete signals

### Slim electromechanical interface modules

ABR-2 electromechanical interface modules complement the ABR-1 range. They are characterized by micro relay technology which allows reduced dimensions and very low switching levels (TTL, HCMOS, analog signals).

The ABR-2 family is in the form of slim compact modules, 9.5 mm wide for input interface modules, 12 mm wide for output interface modules and 17.5 mm wide for very low level switching products.

#### Description

The ABR-2 includes 3 families:

##### Input interfaces (9.5 mm pitch)

Input interfaces are designed for switching input signals to a processor and are characterized by their advanced contact reliability: less than 1 interruption per 100 million operating cycles at  $\pm 17$  V, 5 mA.

They have increased immunity to current leakages  $\leq 2$  mA, and a wide coil voltage range (0.7 to 1.25 Un).

##### Output interfaces (12 mm pitch)

Output interfaces are designed for the control of preactuators (contactors, solenoid valves, etc) for signalling devices (indicators lamps, audible warnings etc). They are characterized by a high switching capacity and an advanced immunity to current leakages  $\leq 2$  mA. A lower cost version without LED signalling is available.

##### Low level switching input and output interfaces (17.5 mm pitch) with 1 C/O contact.

These interfaces are designed for switching logic (TTL or HCMOS) and analog signals.

**Warning:** never switch inductive loads with this type of interface.

The front panel of the ABR-2 electromechanical interface module includes:

- 1 LED indicating the control signal state
- 2 Channel identification : 5 individual characters for AB1-R/G or 1 AB1-SA2 marker tag
- 3 Connection by screw clamp terminal enabling easy attachment of 2 wires per terminal. The layout of the connection terminals for both families (input and output) is designed for rational wiring and a clear separation between the incoming (processing) and outgoing (power and process control) circuits.

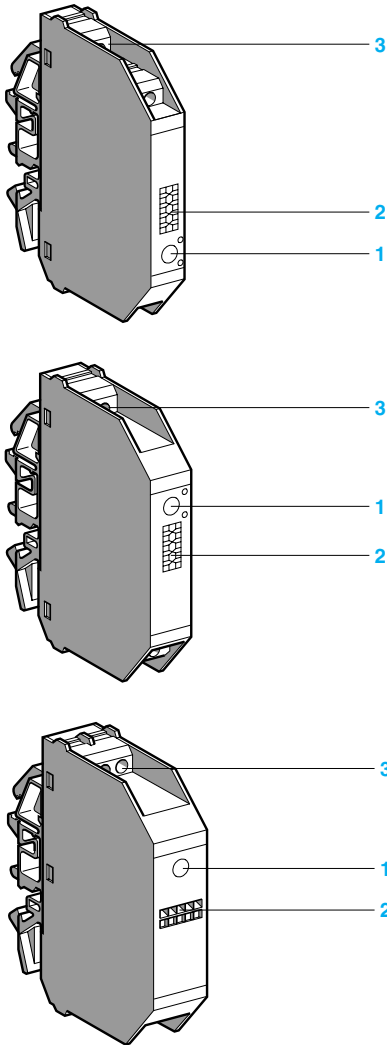

## Examples of applications with PLCs

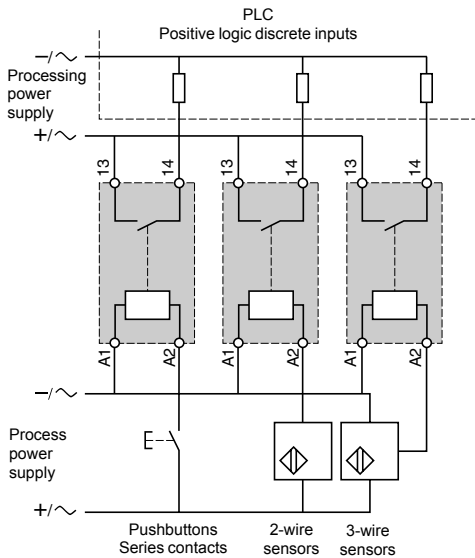

ABR2E●●●●

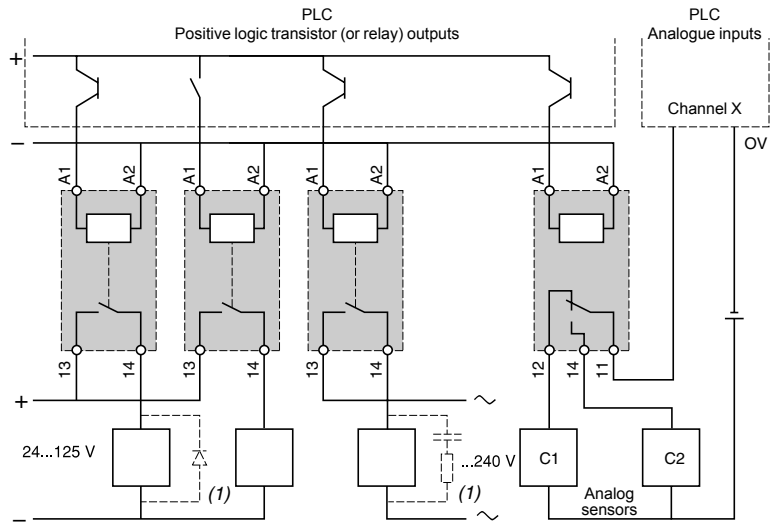

ABR2S●●●●

ABR2SB12B

(1) Essential on inductive loads (can be replaced with peak limiter ).

## Environment

<b>Conforming to standards</b>		IEC 60947-1, UL 508, CSA C22.2 No. 14	
<b>Product certifications</b>		UL, CSA, BV, LROS, DNV	
<b>Degree of protection</b>	Conforming to IEC 529 (protection against direct contact)	IP 20	
<b>Protective treatment</b>		"TC"	
<b>Flame resistance</b>	Conforming to IEC 695-2-1	Incandescent wire	°C 960
		Conforming to UL 94	V0
<b>Shock resistance</b>	Conforming to IEC 68-2-27	Semi-sinusoidal waves 11 ms	30 gn
<b>Vibration resistance</b>	Conforming to IEC 68-2-6	10...150 Hz	3 gn
<b>Resistance to electrostatic discharges</b>	Conforming to IEC 801-2	Level 3	kV 8
<b>Resistance to electromagnetic fields</b>	Conforming to IEC 801-3	Level 3 ; 27...1000 MHz	V/m 10
<b>Resistance to rapid transients</b>	Conforming to IEC 801-4 Level 3	On power supply	kV 2
		On I/O	kV 1
<b>Resistance to shock waves</b>	Conforming to IEC 947-1	Waveform	
		1.2/50 μs ; 0.5 J	U < 50 V kV 0.5
			U < 150 V kV 1.5
			U < 300 V kV 2.5
<b>Cross-sections which may be connected</b>	Flexible wire with no cable end	1 or 2-wire	mm <sup>2</sup> 0.6...2.5
	Flexible wire with cable end	1 or 2-wire	mm <sup>2</sup> 0.34...2.5
	Rigid cable	1-wire	mm <sup>2</sup> 0.27...4
<b>Operating position</b>		Any	
<b>Ambient air temperature</b>	Unrestricted operation	°C	- 5...+ 40
	Operation from 0.85...1.1 Us (assigned voltage)	°C	- 5...+ 55
	Operation restricted to Us (assigned voltage)	°C	- 25...+ 70 (2)
	Storage	°C	- 40...+ 80
<b>Operating altitude</b>		m	≤ 3000
<b>Installation category</b>	Conforming to IEC 947-1		II
<b>Degree of pollution</b>	Conforming to IEC 947-1		2
<b>Mounting</b>			Standard DIN rails

(2) Leave space of 8 mm between ABR-2S1●●● for an ambient temperature ≥ 55 °C

Control circuit characteristics (40°C ambient temperature)									
Type of interface		ABR 2E112B	ABR 2E112E	ABR 2E115F	ABR 2E116F	ABR 2E111M	ABR 2S112B	ABR 2S102B	ABR 2•B312B (1)
Rated voltage (Us)	V	~ 24	~ 48	~ 115...127	~ 120...127	~ 230...240	~ 24	~ 24	~ 24
Current frequency	Hz	–	–	50	60	50/60	–	–	–
Energization threshold	V	16.9	37.3	93	97	186	16.9	14.5	16.9
Maximum operating voltage	V	28.8	57.6	140	140	264	28.8	28.8	28.8
Maximum drop-out voltage (Uo)	V	3.8	8.5	25.4	25.4	48	3.8	2	3.8
Maximum current (at Us)	mA	19.5	11	14	16	15	28	18	23
Minimum holding current	mA	2	2	2.5	2.5	2.5	2	1.3	2
Maximum dissipated power (at Us)	50 Hz	W	–	0.66	–	0.54	–	–	–
	60 Hz	W	0.45	0.52	–	0.73	0.77	0.64	0.43
Disappearance of voltage maximum time up to which contact is maintained	ms	1	1	10	10	10	1	5	1
Display of control circuit by LED		Yes	Yes	Yes	Yes	Yes	Yes	No	Yes
Built-in protection reversed polarity		Yes	Yes	–	–	–	Yes	Yes	Yes

Contact characteristics (40°C ambient temperature)									
Type of interface		ABR2E••••	ABR2S112B	ABR2S102B	ABR2•B312B (1)				
Contact configuration		1 N/O	1 N/O	1 N/O	1 C/O				
Maximum rated operating voltage (Ue max)	~ V	127	230	230	48				
	~ V	100	120	120	48				
Maximum switching voltage	~ V	140	250	250	60				
	~ V	125	150	150	60				
Operating current frequency	Hz	50/60	50/60	50/60	50/60				
Thermal current Ith	A	1	5	5	0.05				
Rated operating current (Ie) for 1 million operating cycles	Conforming to IEC 947-5-1	AC12	A	1	3	–			
		AC14	A	0.5	1	–			
	AC15	A	0.5	1	1	–			
	Conforming to IEC 947-5-1	DC12	A	1	1.7	1.7	–		
		DC13	A	1	1.5	1.5	–		
	Ue : ~ 24 V								
Minimum switching current	mA	1	5	5	0.01				
Minimum switching voltage	V	5	5	5	0.01				
Protection against short-circuits	For I <sub>k</sub> ≤ 1 kA (~) and ≤ 100 A (~) Type and value of recommended fuse	Type : quick-blow fuse with high breaking capacity							
		A	2	6.3	6.3	0.4			
Low level contact performance (17 V, 5 mA) ABR-2•B (30 mV, 10 µA)	Number of interruptions per "n" million operating cycles	1 per 100 million							

Other characteristics									
Maximum operating time at Us (bounce included)	Between energization of coil and closing of N/O contact	~	ms	10	10	10	6		
		~	ms	30	–	–	–		
	Between energization of coil and opening of N/C contact		ms	–	–	–	6		
	Between de-energization of coil and opening of N/O contact	~	ms	6	12	5	6		
		~	ms	30	–	–	–		
	Between de-energization of coil and closing of N/C contact		ms	–	–	–	6		
Maximum duration of bounce		ms	5	5	5	2			
No make before break guaranteed between "N/C" and "N/O" contacts	Maximum make before break	On energization	ms	–	–	–	5		
	On de-energization	before make time	ms	–	–	–	2		
Maximum operating rate	At no-load	Hz	10	10	10	10			
	At Ie	Hz	0.5	0.5	0.5	–			
Mechanical durability in millions of operating cycles			20	10	10	20			
Rated insulation voltage	Conforming to IEC 947-1	V	300	300	300	300			
	Conforming to VDE 0110 group C	V	250	250	250	250			
Insulation test voltage for 1 min	Coil circuit/contact circuits	kV rms	2	4	4	1.5			
	Wired interface/ground	kV rms	2.5	2.5	2.5	2.5			
	Between open contacts	kV rms	0.75	1	1	1			

(1) Do not switch inductive loads.



## Electrical durability of contacts (ABR 2S)

Test conditions : in accordance with standard IEC 947-5-1 set up for rated control voltage.

### a.c. loads

Operating cycles in millions

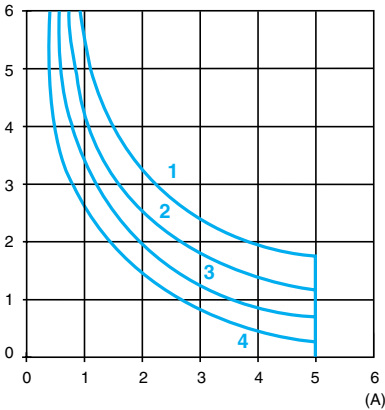

Operating cycles in millions

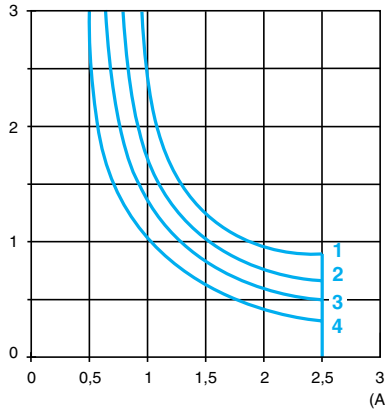

- 1 24 V
- 2 48 V
- 3 115 V
- 4 230 V

AC12 : control of resistive loads and isolated solid state loads via optocoupler  
 $\cos \varphi \geq 0.9$

AC14 : control of weak electro-magnetic loads of electro-magnets  $\leq 72 \text{ VA}$

make :  $\cos \varphi = 0.3$

break :  $\cos \varphi = 0.3$

AC15 : control of electro-magnetic loads of electro-magnets  $> 72 \text{ VA}$

make :  $\cos \varphi = 0.7$

break :  $\cos \varphi = 0.4$

### d.c. loads

Operating cycles in millions

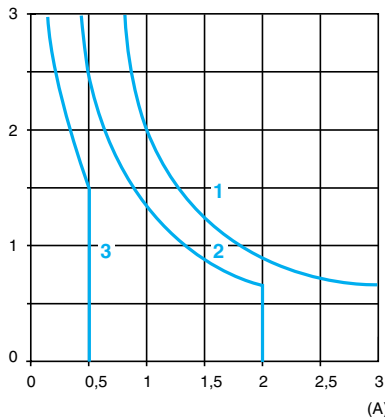

Operating cycles in millions

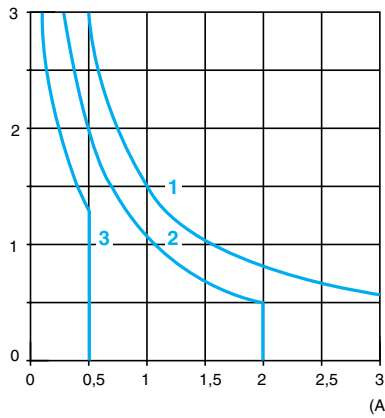

- 1 24 V
- 2 48 V
- 3 115 V

DC12 : control of resistive loads and isolated solid state loads via optocoupler  
 $L/R \leq 1 \text{ ms}$

DC13 : control of electro-magnets

$L/R \leq 2 \times (U_e \times I_e)$  in ms.

$U_e$  : rated operating voltage

$I_e$  : rated operating current

(with a load protection diode)

# Interfaces

For discrete signals  
Slim electromechanical interface modules  
Control circuit: a.c. or d.c.

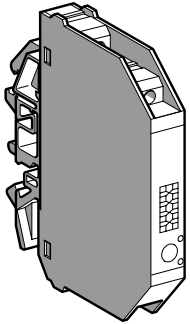

ABR2E112B

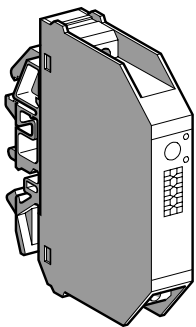

ABR2S112B

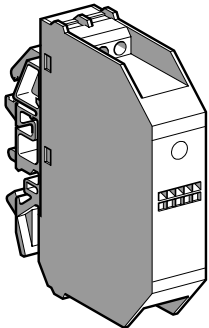

ABR2EB112B

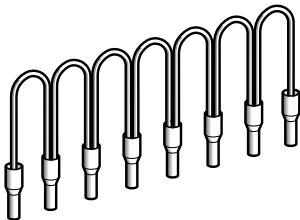

ABFC08R●●●

### Input modules (9.5 mm pitch)

Indication	Contact Configuration	Control circuit	Sold in lots of	Catalog number	Weight
<b>V</b>					
With LED	1 N/O	≡ 24	5	ABR2E112B	0.032
		≡ 48	5	ABR2E112E	0.032
		~ 115...127 (50 Hz)	5	ABR2E115F	0.035
		~ 120...127 (60 Hz)	5	ABR2E116F	0.035
		~ 230...240 (50/60 Hz)	5	ABR2E111M	0.036

### Output modules (12 mm pitch)

Indication	Contact Configuration	Control circuit	Sold in lots of	Catalog number	Weight
<b>V</b>					
Without	1 N/O	≡ 24	5	ABR2S102B	0.040
With LED	1 N/O	≡ 24	5	ABR2S112B	0.041

### Modules for very low level switching (17.5 mm pitch)

Indication	Contact Configuration	Control circuit	Catalog number	Weight
<b>V</b>				
<b>Input</b>				
With LED	1 C/O (1)	≡ 24	ABR2EB312B	0.048
<b>Output</b>				
With LED	1 C/O (1)	≡ 24	ABR2SB312B	0.048

### Flexible comb accessories

Description	For common	Color	Distance between wire ends	Catalog number	Weight
<b>cm</b>					
Flexible comb modularity 8 x 1 mm <sup>2</sup>	Coil	White	12	ABFC08R12W	0.020
			2	ABFC08R02W	0.010
	~	Red	12	ABFC08R12R	0.020
			2	ABFC08R02R	0.010
	≡	Blue	12	ABFC08R12B	0.020
			2	ABFC08R02B	0.010

(1) Not for use with inductive loads.

## Dimensions (mm):

**ABR2E11●●**

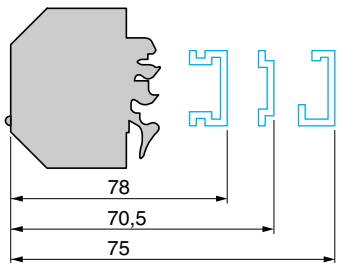

**ABR2S1●2B**

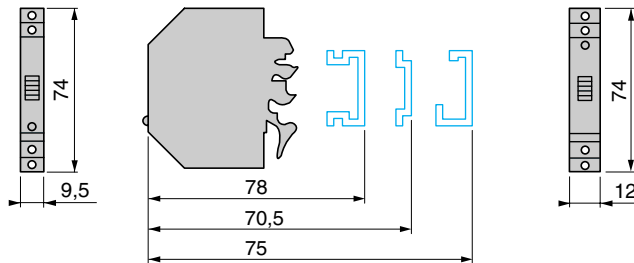

**ABR2EB312B**

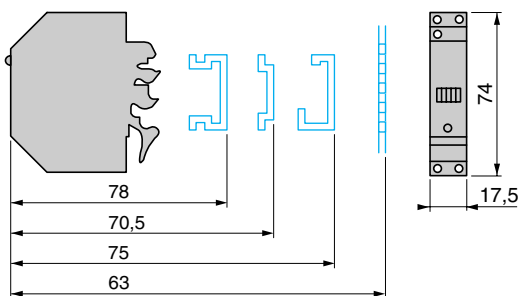

**ABR2SB312B**

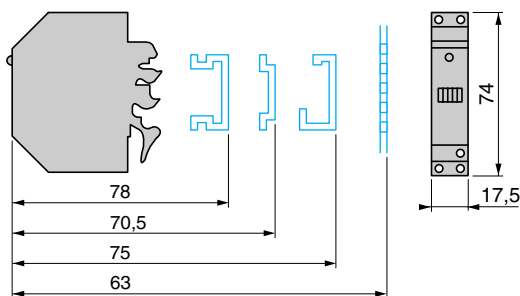

## Circuit diagrams

**ABR2E112B** ( $\approx$  24 V)

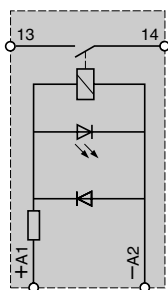

**ABR2E112E** ( $\approx$  48 V)

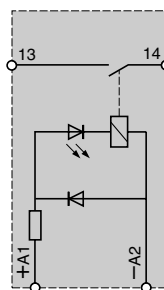

**ABR2E11●F/M** ( $\sim$  115...240 V)

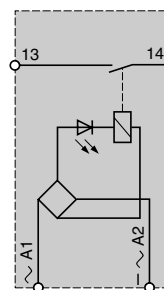

**ABR2S102B** ( $\approx$  24 V)

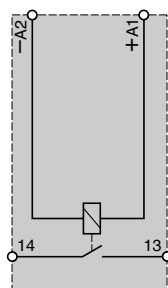

**ABR2S112B** ( $\approx$  24 V)

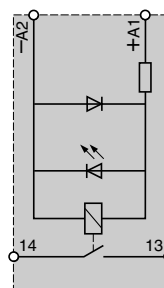

**ABR2●B312B** ( $\approx$  24 V)

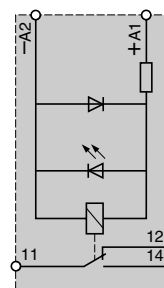

# Interfaces

## For discrete signals

### Slim solid-state interface modules

The ABS-2 solid-state interface relays are supplied in the form of compact modules which appear identical to the ABR-2 electromechanical family.

They are designed for interfacing discrete digital control signals exchanged within an automated system between the processor (PLC, numerical controller, etc) and the other components (contactors, solenoid valves, indicator lamps, proximity sensors). They are suitable for use in equipment which requires the benefits of electronic technology: a high operating rate, enhanced durability, silent operation.

These products are notable for their high performance and excellent adaptation to industrial environments. They also conform to the most recent IEC standards.

#### Composition

The ABS-2 range includes 2 families:

#### Input interfaces

The 9.5 mm wide input interfaces are designed for switching input signals to processors. They offer a wide choice of electrical isolation between signals due to the wide range of input voltages from  $\approx 5$  V to  $\sim 230$  V.

#### Output interfaces

Output interfaces are designed for the control of preactuators (contactors, solenoid valves, etc) for the signalling devices (indicator lamps, audible warnings, etc).

Two widths are available, 9.5 and 17.5 mm, depending on the switched current.

The 17.5 mm version includes a 9.5 mm interface and an integrated 8 mm spacer. This device can, with its increased ventilation, switch high levels of currents.

The front panel of the ABS-2 slim solid-state interface modules includes:

- 1 LED indicating the state of the control signal.
  - 2 Channel identification : 5 individual characters for AB1-/G or one AB1-SA2 marker tag.
  - 3 Connection by screw clamp terminal enabling easy attachment of 2 wires per terminal.
  - 4 Integrated spacer.
- The layout of the connection terminals for both families (input and output) is designed for rational wiring and a clear separation between the incoming (processing) and outgoing (power and process control) circuits.

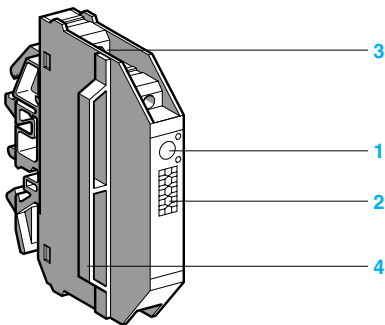
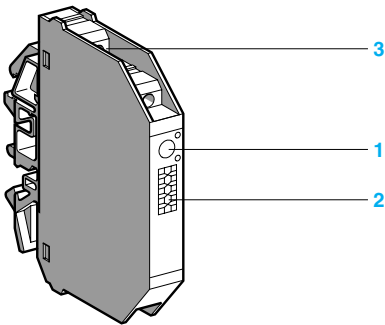
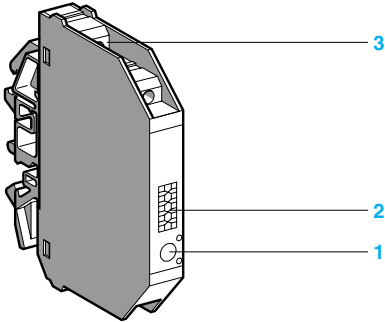

### Examples of applications with PLCs

#### Interfacing PLC discrete inputs

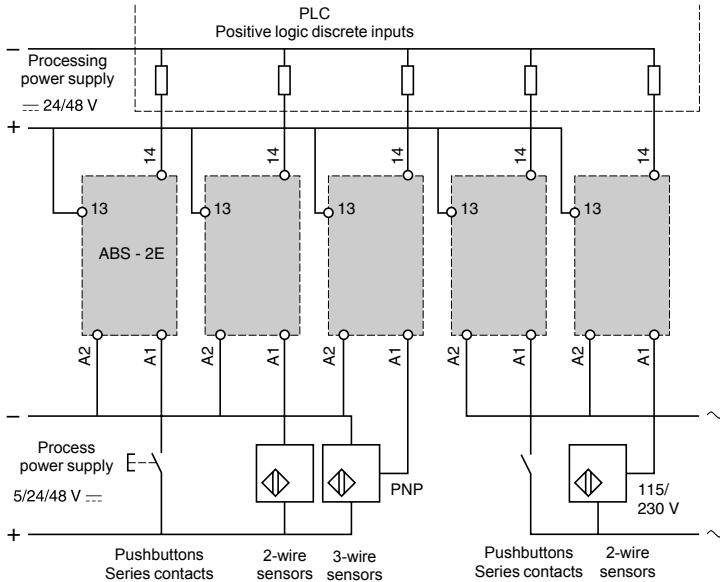

#### Interfacing PLC discrete outputs

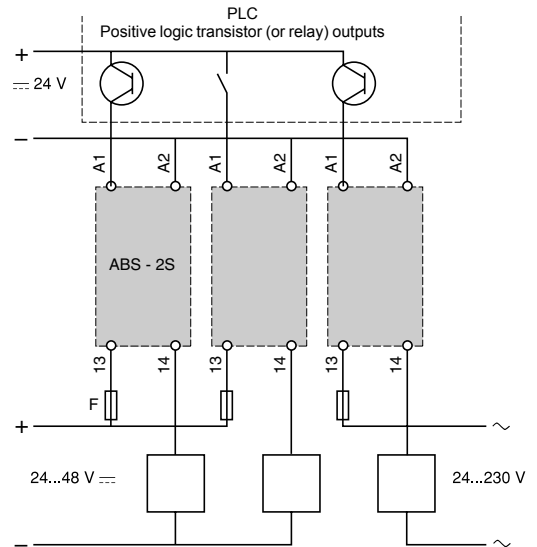

### Environment

<b>Conforming to standards</b>		IEC 60947-1, UL 508, CSA C22.2 No. 14	
<b>Product certifications</b>		UL, CSA, BV, LROS, DNV	
<b>Degree of protection</b>	Conforming to IEC 529 (protection against direct contact)	IP 20	
<b>Protective treatment</b>		"TC"	
<b>Flame resistance</b>	Conforming to IEC 695-2-1	Incandescent wire	°C 960
		Conforming to UL 94	V0
<b>Shock resistance</b>	Conforming to IEC 68-2-27	Semi-sinusoidal waves 11 ms	30 gn
<b>Vibration resistance</b>	Conforming to IEC 68-2-6	10...150 Hz	5 gn
<b>Resistance to electrostatic discharges</b>	Conforming to IEC 801-2	Level 3	kV 8
<b>Resistance to electromagnetic fields</b>	Conforming to IEC 801-3	Level 3 ; 27...1000 MHz	V/m 10
<b>Resistance to rapid transients</b>	Conforming to IEC 801-4 Level 3	On power supply	kV 2
		On I/O	kV 1
<b>Resistance to shock waves</b>	Conforming to IEC 947-1	Waveform	kV 0.5
		1.2/50 ms ; 0.5 J	U < 50 V kV 1.5
			U < 150 V kV 2.5
			U < 300 V kV 2.5
<b>Cross-sections which may be connected</b>	Flexible wire with no cable end	1 or 2-wire	mm <sup>2</sup> 0.6...2.5
	Flexible wire with cable end	1 or 2-wire	mm <sup>2</sup> 0.34...2.5
	Rigid cable	1-wire	mm <sup>2</sup> 0.27...4
<b>Operating position</b>		Any	
<b>Ambient air temperature around the device</b>	Unrestricted operation	°C	- 5...+ 55
	Operation at Us	°C	- 25...+ 70
	Storage	°C	- 40...+ 80
<b>Operating altitude</b>		m	≤ 300
<b>Installation category</b>	Conforming to IEC 947-1	II	
<b>Degree of pollution</b>	Conforming to IEC 947-1	2	
<b>Mounting</b>		Standard DIN rails	

Control circuit characteristics (55°C ambient temperature)									
Type of interface			ABS 2EC01EA	ABS 2EC01EB	ABS 2EC01EE	ABS 2EA01EF	ABS 2EA02EF	ABS 2EA01EM	ABS 2EA02EM
Rated voltage $U_s$	≡	V	5	24	48	–	–	–	–
	~	V	–	–	–	115/127 50 Hz	120/127 60 Hz	230/240 50 Hz	230/240 60 Hz
Maximum voltage	≡	V	Negative logic 6 (TTL)	28.8	57.6	–	–	–	–
	~	V	–	–	–	140	140	264	264
Maximum current at $U_s$	≡	mA	13.6	12	10.5	–	–	–	–
	~	mA	–	–	–	14	17	12.5	15
State 1	≡	V	3.75	16.9	36	–	–	–	–
		mA	4.5	7.7	7.5	–	–	–	–
	~	V	–	–	–	86.3	90	173	173
State 0		mA	–	–	–	8.4	9.7	7.9	9.3
	≡	V	2	5.6	10.8	–	–	–	–
		mA	0.09	2	2	–	–	–	–
	~	V	–	–	–	25.4	25.4	48	48
		mA	–	–	–	2.5	2.5	2.5	2.5
State 1 display			Yes	Yes	Yes	Yes	Yes	Yes	Yes
Internal protection reversed polarity			Yes	Yes	Yes	–	–	–	–
Output circuit characteristics									
Rated operating voltage $U_e$	≡	V	5...48						
Min/max voltage	≡	V	2/60						
Min/max current switched		mA	1/50						
Maximum residual current at state 0		mA	0.1						
Maximum volt drop at state 1		V	1						
Internal protection			Reversed polarity						
External protection			Against short-circuits for $I_k \leq 100$ A (≡) Quick-blow fuse, ref. : HA21 0.25 A or equivalent						
Other characteristics									
Type of interface			ABS 2EC01EA	ABS 2EC01EB	ABS 2EC01EE	ABS 2EA01EF	ABS 2EA02EF	ABS 2EA01EM	ABS 2EA02EM
Time delay characteristics	0 → 1	ms	0.05	0.05	0.05	10	10	10	10
	1 → 0	ms	0.4	0.4	0.4	20	20	20	20
Maximum switching rate		Hz	1000	1000	1000	25	25	25	25
Duty cycle 50 % $U_e \leq 30$ V $I_e \geq 5$ mA									
Rated insulation voltage			Conforming to IEC 947-1 : 300 V Conforming to VDE 0110 : 250 V group C						
Insulation test voltage for 1 minute	I/O	kVrms	4						
	Wired interface/ground	kVrms	2.5						

Control circuit characteristics (55°C ambient temperature)						
Type of interface		ABS2SC01EB	ABS2SC02EB	ABS2SA01MB	ABS2SA02MB	
Rated voltage $U_s$	---	V	24	24	24	
Maximum voltage		V	28.8	28.8	28.8	
Maximum current at $U_s$		mA	12	13.6	13.6	
State 1		V	16.9	16.9	16.9	
		mA	7.7	8.3	8.3	
State 0		V	5.6	5.3	5.3	
		mA	2	2	2	
State 1 display			Yes	Yes	Yes	
Internal protection reversed polarity			Yes	Yes	Yes	
Output circuit characteristics						
Rated operating voltage $U_e$		V	--- 5...48	--- 5...48	~ 24...240	~ 24...240
Maximum voltage		V	--- 57.6	--- 57.6	~ 264	~ 264
Maximum continuous current (Ith) (1) at 40 °C		A	2	3	2.3	3
Rated operating voltage (Ie) Conforming to IEC 947-5-1 Single/touching product at 55 °C vertical position		A	DC12 1.5/0.9	2.5/2.2	AC12 1.9/0.5	2.1/1.5
		A	DC13 1.5/0.9	2.5/2.2	AC13 1.6/0.5	1.6/1.5
		A	DC14 0.6/0.6	0.6/0.6	AC14 1.6/0.5	1.6/1.5
		A	– –	–	AC15 1/0.5	1/1
Minimum current	---/~	mA	1	1	10	10
Maximum residual current	---/~	mA	1	1	2.5	2.5
Maximum volt drop		V	1.5	1.5	3 (Ie ≥ 10 mA) 1.5 (Ie ≥ 100 mA)	3 (Ie ≥ 10 mA) 1.5 (Ie ≥ 100 mA)
"0 crossing" voltage		V	–	–	50 peak	50 peak
Solid-state dV/dt		V/μs	–	–	500	500
Internal protection			Reversed polarity			
External protection			Against short-circuits for I <sub>k</sub> ≤ 1 kA (~) and ≤ 100 A (---) Quick-blow fuse with high breaking capacity: 3.15 A			
Other characteristics						
Maximum response time at I <sub>e</sub> □ 10 mA	0 → 1	ms	0.05		10 (50 Hz) ; 8 (60Hz)	
	1 → 0	ms	0.6		10 (50 Hz) ; 8 (60Hz)	
Maximum switching rate At 55 °C ; at I <sub>e</sub> : module alone duty cycle 40 %  On resistive load duty cycle 50 %		Hz	DC13 6	6	AC13 0.6	0.7
		Hz	DC14 1	3	AC14 0.6	0.7
		Hz	– –	–	AC15 0.6	0.7
		Hz	700		50	
Rated operating voltage			Conforming to IEC 947-1 : ~ 300 V			
			Conforming to VDE 0110 : 250 V group C			
Rated Insulation voltage for 1 minute	I/O	kVrms	4			
	Wired interface/ground	kVrms	2.5			

(1) See temperature derating curves.

## Solid-state input modules

Width mm	Input circuit		Output circuit		Sold in lots of	Catalog number	Weight kg
	Current	Nominal voltage V	Current	Nominal voltage V			
9.5	—	5	—	5...48	5	ABS2EC01EA	0.029
		24	—	5...48	5	ABS2EC01EB	0.029
		48	—	5...48	5	ABS2EC01EE	0.029
	~	115...127 (50 Hz)	—	5...48	5	ABS2EA01EF	0.032
		120...127 (60 Hz)	—	5...48	5	ABS2EA02EF	0.032
		230...240 (50 Hz)	—	5...48	5	ABS2EA01EM	0.033
		230...240 (60 Hz)	—	5...48	5	ABS2EA02EM	0.033

## Solid-state output modules

Width mm	Input circuit		Output circuit		Sold in lots of	Catalog number	Weight kg
	Current	Nominal voltage V	Current A	Nominal voltage V			
9.5	—	24	— 2	24...48	5	ABS2SC01EB	0.034
			~ 2.3	24...230	5	ABS2SA01MB	0.034
17.5	—	24	— 3	24...48	1	ABS2SC02EB	0.043
			~ 3	24...230	1	ABS2SA02MB	0.044

## Accessories

For connecting commons, use **ABFC08●●●** flexible combs (Please consult your Regional Sales Offices).

## Temperature derating curve for solid-state output modules $U_c = U_s = \text{—} 24 \text{ V}$

ABS2SC01EB d.c.

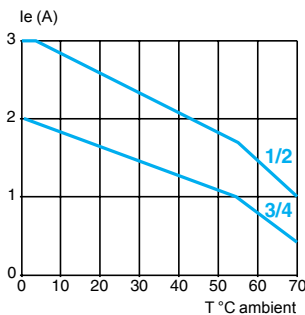

ABS2SC02EB d.c.

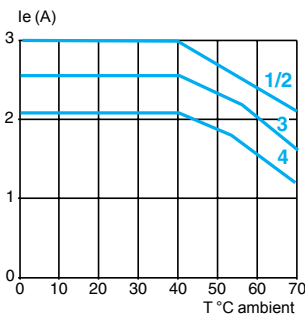

ABS2SA01MB a.c.

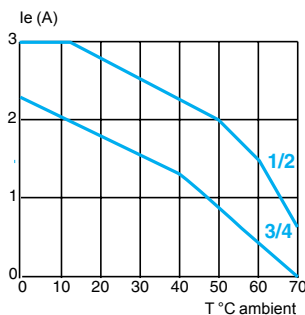

ABS2SA02MB a.c.

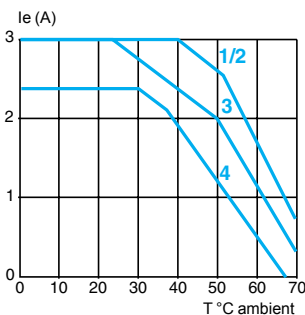

- 1 Vertical module alone or adjacent to modules with low heat dissipation.

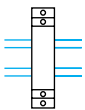

- 2 Horizontal module alone or adjacent to modules with low heat dissipation.

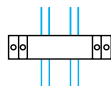

- 3 Vertical module mounted with 2 modules with identical heat dissipation on both sides.

- 4 Horizontal module mounted with 2 modules with identical heat dissipation on both sides.



## Dimensions (mm):

ABS2E/ABS 2S●01●●

ABS2S●02●●

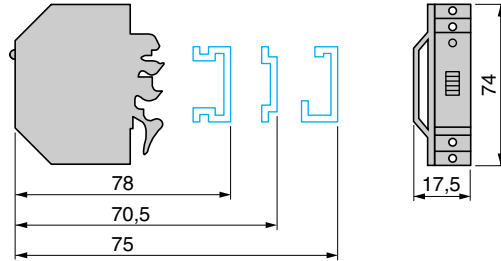
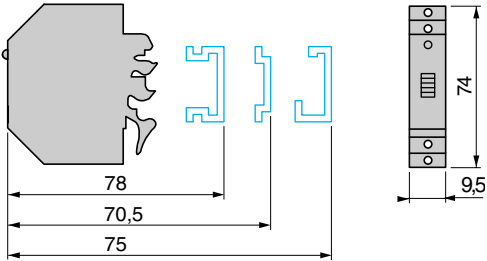

## Circuit diagrams

### Solid-state input modules

ABS2EC●●●●

ABS2EA●●●●

ABS2E●●●●

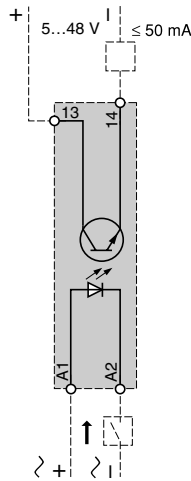
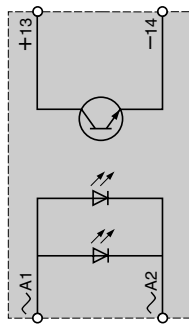
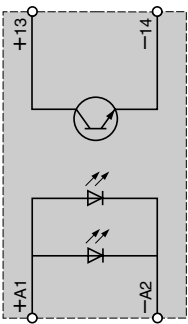

### Solid-state output modules

ABS2SC0●EB

ABS2SA0●MB

ABS2SC0●EB

ABS2SA0●MB

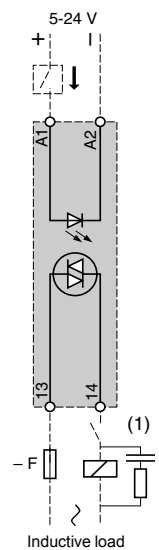
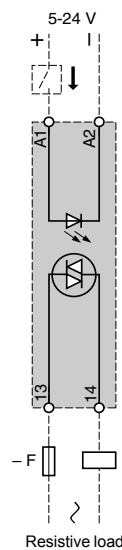
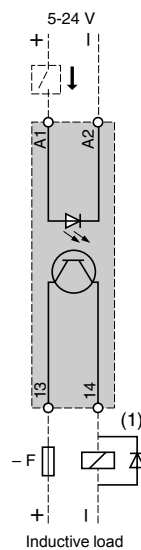
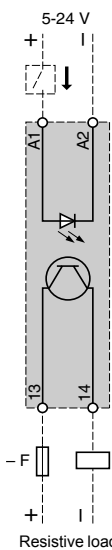
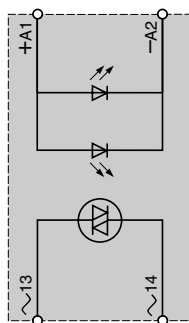
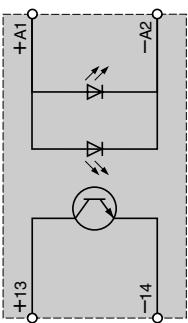

F: fuse DF1 SS133.2  
(1) or peak limiter

**Applications**

**Panel mounted**



<b>Contact type</b>	1 N/O SPST contact
<b>Control voltage ranges</b>	90...280 V 3...32 V, 3.5...32 V
<b>Operating voltages</b>	24...280 V, 48...530 V, 48...660 V 0...100 V
<b>Type of switching</b>	Zero voltage switching DC switching
<b>Current</b>	10, 25, 50, 75, 90, 125 A 12, 25, 40
<b>Degree of protection</b>	IP20
<b>LED indication</b>	Yes
<b>Cooling</b>	Thermal protection or with heat sink accessory
<b>Solid state relay type</b>	<b>SSRP</b>
<b>Page</b>	76

## DIN rail mounted



1 N/O SPST contact

90...280 V

90...140 V

4...32 V

3...32 V

24...280 V

Zero voltage switching

10, 20, 30 A

45 A

IP20

Yes

Built-in heat sink

## SSRD

76

## Introduction

The **SSR** solid state relay range includes:

- relays for panel mounting: **SSRP**.
- relays for DIN rail mounting: **SSRD**.

## Description

### SSRP relays for panel mounting

- 1 2 x Ø 4.9 holes for mounting.
- 2 Connection terminals.
- 3 Connection terminal screws.
- 4 Input voltage indicator LED, green.
- 5 Thermal interface which must be via the back of the product.



### SSRD relays for DIN rail mounting

- 1 Lugs for plate mounting.
- 2 Built-in heat sink.
- 3 Connection terminals.
- 4 Connection terminal screws.
- 5 Input voltage indicator LED, green.
- 6 Bracket for mounting on 35 mm DIN rail.



## General characteristics

### SSRP solid state relays, panel mounting

<b>Product certifications</b>			UR E258297, CSA LR 40787, IEC 60950-1, IEC 62314
<b>Product marking</b>			CE
<b>Ambient air temperature</b> around the device	Storage	°C	- 40...+ 80
	Operation	°C	- 40...+ 125
<b>Encapsulation</b>			Thermally conductive epoxy
<b>Degree of protection</b>			IP20 (with cover), IP00 (without cover)
<b>Terminal screw torque</b>		<b>Nm</b>	Inputs: 1.1 (screw: Ø 3.5 / length 6 mm) Outputs: 2.2 (screw: Ø 4 / length 7.4 mm)

### SSRD solid state relay, DIN rail mounting

<b>Product certifications</b>			UR E258297, CSA LR 40787, IEC 60950-1, IEC 62314
<b>Product marking</b>			CE
<b>Ambient air temperature</b> around the device	Storage	°C	- 40...+ 80
	Operation	°C	- 40...+ 125
<b>Encapsulation</b>			Thermally conductive epoxy
<b>Degree of protection</b>			IP20
<b>Terminal screw torque</b>	10...30 A relays	<b>Nm</b>	Inputs: 0.6...0.7 / Outputs: 0.6...0.7
	45 A relays	<b>Nm</b>	Inputs: 0.6...0.7 / Outputs: 1.1...1.7
<b>Max. wire size</b>	10...30 A relays		Inputs: 5.3 mm <sup>2</sup> - AWG 10 / Outputs: 5.3 mm <sup>2</sup> - AWG 10
	45 A relays		Inputs: 3.3 mm <sup>2</sup> - AWG 12 / Outputs: 8.4 mm <sup>2</sup> - AWG 8

SSRP solid state relays, panel mounting				
Relay type	SCR output, Zero voltage switching	SSRPCDS10A1	SSRPCDS25A1	SSRPCDS50A1
<b>Input specification</b>				
Control voltage range	$\overline{\text{---}} \text{ V}$	3...32	3...32	3...32
Maximum turn-on voltage	$\overline{\text{---}} \text{ V}$	3	3	3
Maximum turn-off voltage	$\overline{\text{---}} \text{ V}$	1.0	1.0	1.0
Maximum typical input current	<b>mA</b>	10 at $\overline{\text{---}}$ 12 V	10 at $\overline{\text{---}}$ 12 V	10 at $\overline{\text{---}}$ 12 V
<b>Output specification</b>				
Operating voltage	$\sim \text{ V}$	24...280	24...280	24...280
Load current range	<b>A</b>	0.15...10	0.15...25	0.15...50
Transient overvoltage	<b>Vpk</b>	600	600	600
Maximum surge current (16.6 ms)	<b>Apk</b>	120	250	625
Maximum On-state voltage drop at rated current	<b>Vrms</b>	1.6	1.6	1.6
Thermal resistance junction to base plate	$^{\circ}\text{C/W}$	1.48	1.02	0.63
Maximum I <sup>2</sup> t for fusing (8.3 ms)	<b>A<sup>2</sup>sec</b>	60	260	1620
Maximum off-state leakage current at rated voltage	<b>mA</b>	1.0	1.0	1.0
Minimum off-state dv/dt at maximum rated voltage	<b>V/μsec</b>	500	500	500
Maximum turn-on time	<b>Cycle</b>	1/2	1/2	1/2
Maximum turn-off time	<b>Cycle</b>	1/2	1/2	1/2
Relay type	SCR output, Zero voltage switching	SSRPCDS75A2	SSRPCDS90A3	SSRPCDS125A3
<b>Input specification</b>				
Control voltage range	$\overline{\text{---}} \text{ V}$	3...32	3...32	3...32
Maximum turn-on voltage	$\overline{\text{---}} \text{ V}$	3	3	3
Maximum turn-off voltage	$\overline{\text{---}} \text{ V}$	1.0	1.0	1.0
Typical input current	<b>mA</b>	10 at $\overline{\text{---}}$ 12 V	10 at $\overline{\text{---}}$ 12 V	10 at $\overline{\text{---}}$ 12 V
<b>Output specification</b>				
Operating voltage	$\sim \text{ V}$	48...530	48...660	48...660
Load current range	<b>A</b>	0.15...75	0.25...90	0.25...125
Transient overvoltage	<b>Vpk</b>	1200	1200	1200
Maximum surge current (16.6 ms)	<b>Apk</b>	1110	1350	2000
Maximum On-state voltage drop at rated current	<b>Vrms</b>	1.6	1.7	1.7
Thermal resistance junction to base plate	$^{\circ}\text{C/W}$	0.31	0.28	0.22
Maximum I <sup>2</sup> t for fusing (8.3 ms)	<b>A<sup>2</sup>sec</b>	4150	6000	12 700
Maximum off-state leakage current at rated voltage	<b>mA</b>	1.0	1.0	1.0
Minimum off-state dv/dt at maximum rated voltage	<b>V/μsec</b>	500	500	500
Maximum turn-on time	<b>Cycle</b>	1/2	1/2	1/2
Maximum turn-off time	<b>Cycle</b>	1/2	1/2	1/2
Relay type	SCR output, Zero voltage switching	SSRPP8S10A1	SSRPP8S25A1	SSRPP8S50A1
<b>Input specification</b>				
Operating voltage	$\sim \text{ V}$	90...280	90...280	90...280
Maximum turn-on voltage	<b>Vrms</b>	90	90	90
Maximum turn-off voltage	<b>Vrms</b>	10	10	10
Typical input current	<b>mA</b>	6 at 120 Vrms	6 at 120 Vrms	6 at 120 Vrms
<b>Output specification</b>				
Operating voltage	$\sim \text{ V}$	24...280	24...280	24...280
Load current range	<b>A</b>	0.15...10	0.15...25	0.15...50
Transient overvoltage	<b>Vpk</b>	600	600	600
Maximum surge current (16.6 ms)	<b>Apk</b>	400	600	850
Maximum On-state voltage drop at rated current	<b>Vrms</b>	1.6	1.6	1.6
Thermal resistance junction to base plate	$^{\circ}\text{C/W}$	1.48	1.02	0.63
Maximum I <sup>2</sup> t for fusing (8.3 ms)	<b>A<sup>2</sup>sec</b>	60	260	1620
Maximum off-state leakage current at rated voltage	<b>mA</b>	10 max.	10 max	10 max
Minimum off-state dv/dt at maximum rated voltage	<b>V/μsec</b>	500	500	500
Maximum turn-on time	<b>ms</b>	10 max.	10 max.	10 max.
Maximum turn-off time	<b>ms</b>	40 max.	40 max.	40 max.
Relay type	Mosfet output	SSRPCDM12D5	SSRPCDM25D5	SSRPCDM40D5
<b>Input specification</b>				
Control voltage range (input voltage)	$\overline{\text{---}} \text{ V}$	3.5...32	3.5...32	3.5...32
Maximum turn-on voltage	$\overline{\text{---}} \text{ V}$	3.5	3.5	3.5
Maximum turn-off voltage	$\overline{\text{---}} \text{ V}$	1.0	1.0	1.0
Typical input current	<b>mA</b>	1.6 ( $\overline{\text{---}}$ 5 V), 28 ( $\overline{\text{---}}$ 32 V)	1.6 ( $\overline{\text{---}}$ 5 V), 28 ( $\overline{\text{---}}$ 32 V)	1.6 ( $\overline{\text{---}}$ 5 V), 28 ( $\overline{\text{---}}$ 32 V)
<b>Output specification</b>				
Control voltage range	$\overline{\text{---}} \text{ V}$	0...100	0...100	0...100
Load current range	<b>A</b>	12	25	40
Minimum load current	<b>mA</b>	0	0	0
Maximum surge current (16.6 ms)	<b>Apk</b>	28	51	106
Maximum On-state voltage drop at rated current	<b>Vpk</b>	1.6	2.1	2.1
Thermal resistance junction to base plate	$^{\circ}\text{C/W}$	1.34	0.83	0.83
Maximum off-state leakage current at rated voltage	<b>mA</b>	0.2	0.3	0.3
On-state resistance	$\Omega$	0.13	0.05	0.05
Maximum turn-on time	<b>μsec</b>	100	100	100
Maximum turn-off time	<b>msec</b>	1.0	1.0	1.0

SSRP solid state relays, panel mounting (continued)					
Relay type	SCR output, Zero voltage switching	SSRPP8S75A2	SSRPP8S90A3	SSRPP8S125A3	
<b>Input specification</b>					
Operating voltage	~ V	90...280	90...280	90...280	
Maximum turn-on voltage	Vrms	90	90	90	
Maximum turn-off voltage	Vrms	10	10	10	
Typical input current	mA	6 at 120 Vrms	6 at 120 Vrms	6 at 120 Vrms	
<b>Output specification</b>					
Operating voltage	~ V	48...530	48...660	48...660	
Load current range	A	0.15...75	0.25...90	0.25...125	
Transient overvoltage	Vpk	1200	1200	1200	
Maximum surge current (16.6 ms)	Apk	1110	1350	2000	
Maximum On-state voltage drop at rated current	Vrms	1.6	1.7	1.7	
Thermal resistance junction to base plate	°C/W	0.31	0.28	0.22	
Maximum I <sup>2</sup> t for fusing (8.3 ms)	A <sup>2</sup> sec	4150	6000	12 700	
Maximum off-state leakage current at rated voltage	mA	10 max.	5 max.	5 max.	
Minimum off-state dv/dt at maximum rated voltage	V/μsec	500	500	500	
Maximum turn-on time	ms	10 max.	10 max.	10 max.	
Maximum turn-off time	ms	40 max.	40 max.	40 max.	
SSRD solid state relay, DIN rail mounting					
Relay type	SCR output, Zero voltage switching	SSRDP8S10A1	SSRDP8S20A1	SSRDP8S30A1	SSRDF8S45A1
<b>Input specification</b>					
Operating voltage	~ V	90...280	90...280	90...280	90...140
Maximum turn-on voltage	Vrms	90	90	90	90
Maximum turn-off voltage	Vrms	10	10	10	10
Typical input current	mA	2 (120 Vrms), 4 (240 Vrms)	2 (120 Vrms), 4 (240 Vrms)	2 (120 Vrms), 4 (240 Vrms)	15 (120 Vrms)
<b>Output specification</b>					
Operating voltage	~ V	24...280	24...280	24...280	24...280
Load current range	A	10	20	30	45
Transient overvoltage	Vpk	600	600	600	600
Maximum surge current (16.6 ms)	Apk	120	250	625	625
Maximum On-state voltage drop at rated current	Vrms	1.6	1.6	1.6	1.6
Maximum I <sup>2</sup> t for fusing (8.3 ms)	A <sup>2</sup> sec	60	260	1620	1620
Maximum off-state leakage current at rated voltage	mA	10	10	10	10
Minimum off-state dv/dt at maximum rated voltage	V/μsec	500	500	500	500
Maximum turn-on time	ms	10 max.	10 max.	10 max.	10 max.
Maximum turn-off time	ms	40 max.	40 max.	40 max.	40 max.
Relay type	SCR output, Zero voltage switching	SSRDCDS10A1	SSRDCDS20A1	SSRDCDS30A1	SSRDCDS45A1
<b>Input specification</b>					
Control voltage range	≡ V	4...32	4...32	4...32	3...32
Maximum turn-on voltage	≡ V	4.0	4.0	4.0	4.0
Maximum turn-off voltage	≡ V	1.0	1.0	1.0	1.0
Typical input current	mA	8...12	8...12	8...12	17
<b>Output specification</b>					
Operating voltage	~ V	24...280	24...280	24...280	24...280
Load current range	A	10	20	30	45
Transient overvoltage	Vpk	600	600	600	600
Maximum surge current (16.6 ms)	Apk	120	250	625	625
Maximum On-state voltage drop at rated current	Vrms	1.6	1.6	1.6	1.6
Maximum I <sup>2</sup> t for fusing (8.3 ms)	A <sup>2</sup> sec	60	260	1620	1620
Maximum off-state leakage current at rated voltage	mA	10	10	10	10
Minimum off-state dv/dt at maximum rated voltage	V/μsec	500	500	500	500
Maximum turn-on time	Cycle	1/2	1/2	1/2	1/2
Maximum turn-off time	Cycle	1/2	1/2	1/2	1/2



SSR PCDS25A1



SSR DCDS10A1



SSR DCDS45A1



SSR AH1



SSR AT1

### Solid state relays, 1 N/O SPST contact

#### ■ Panel mounting

Switching	Voltage range		Load current range	Catalog numbers	Weight	
	Input	Output				
	V	V	A		kg	
<b>SCR output</b>						
Zero voltage switching	~ 3...32	~ 24...280	10	SSRPCDS10A1	0.113	
			25	SSRPCDS25A1	0.113	
			50	SSRPCDS50A1	0.113	
	~ 48...530		75	SSRPCDS75A2	0.113	
		~ 48...660		90	SSRPCDS90A3	0.113
				125	SSRPCDS125A3	0.113
~ 90...280	~ 24...280		10	SSRPP8S10A1	0.113	
			25	SSRPP8S25A1	0.113	
			50	SSRPP8S10A1	0.113	
		75	SSRPP8S75A2	0.113		
		90	SSRPP8S90A3	0.113		
		125	SSRPP8S125A3	0.113		

#### Mosfet output

DC switching	~ 3.5...32	~ 0...100	12	SSRPCDM12D5	0.113
			25	SSRPCDM25D5	0.113
			40	SSRPCDM40D5	0.113

#### ■ DIN rail mounting

<b>SCR output</b>						
Zero voltage switching	~ 90...280	~ 24...280	10	SSRDP8S10A1	0.272	
			20	SSRDP8S20A1	0.272	
			30	SSRDP8S30A1	0.272	
~ 90...140	~ 24...280	45	SSRDF8S45A1	0.482		
		~ 4...32	~ 24...280	10	SSRDCDS10A1	0.272
				20	SSRDCDS20A1	0.272
		30	SSRDCDS30A1	0.272		
~ 3...32	~ 24...280	45	SSRDCDS45A1	0.482		

### Accessories for panel mounted relays

Description	For use with 10...50A relays (1)	Catalog numbers	Weight kg
Heat sink	SSR PP8S●●●●, SSR PCDS●●●●, SSR PCDM●●●●	SSRAH1	0.487
Thermal interface Sold in lots of 10	SSR PP8S●●●●, SSR PCDS●●●●, SSR PCDM●●●●	SSRAT1	0.011

(1) for load current range 75, 90 and 125 A relays, please contact your Customer Care Center.

## Solid state relays, 1 N/O SPST contact

### ■ Panel mounting

#### Solid state relays SSRP

#### Thermal interface SSRAT1

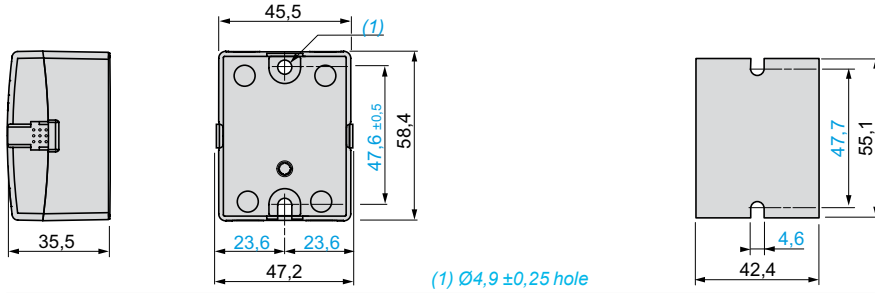

#### Heat sink SSRAH1

#### Heat sink dissipation curve

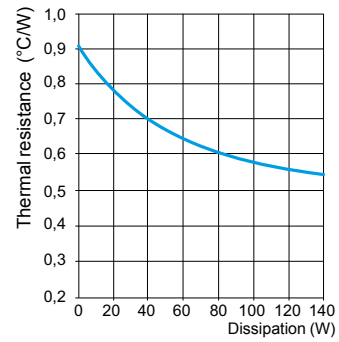
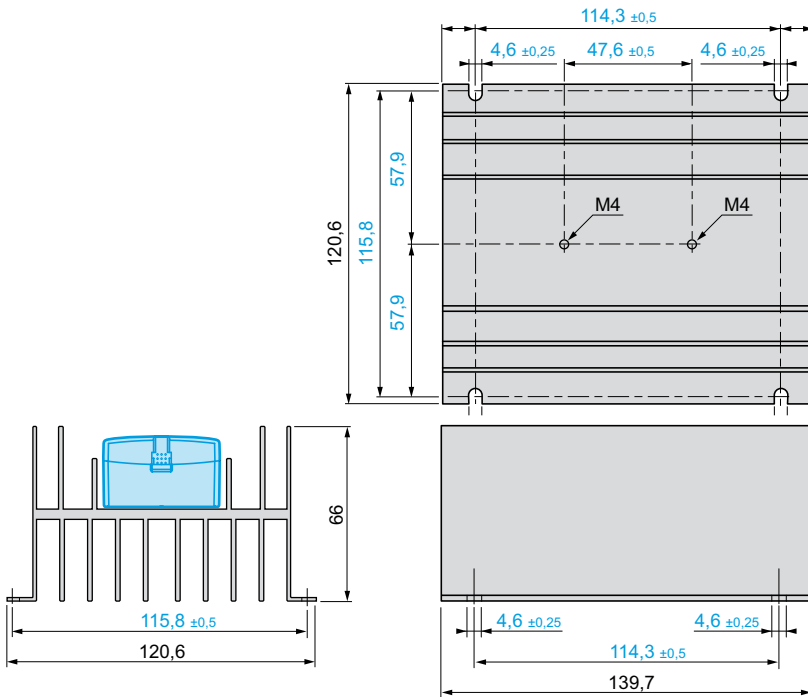

### ■ DIN rail mounting

#### 10...30 A relays

#### 45 A relays

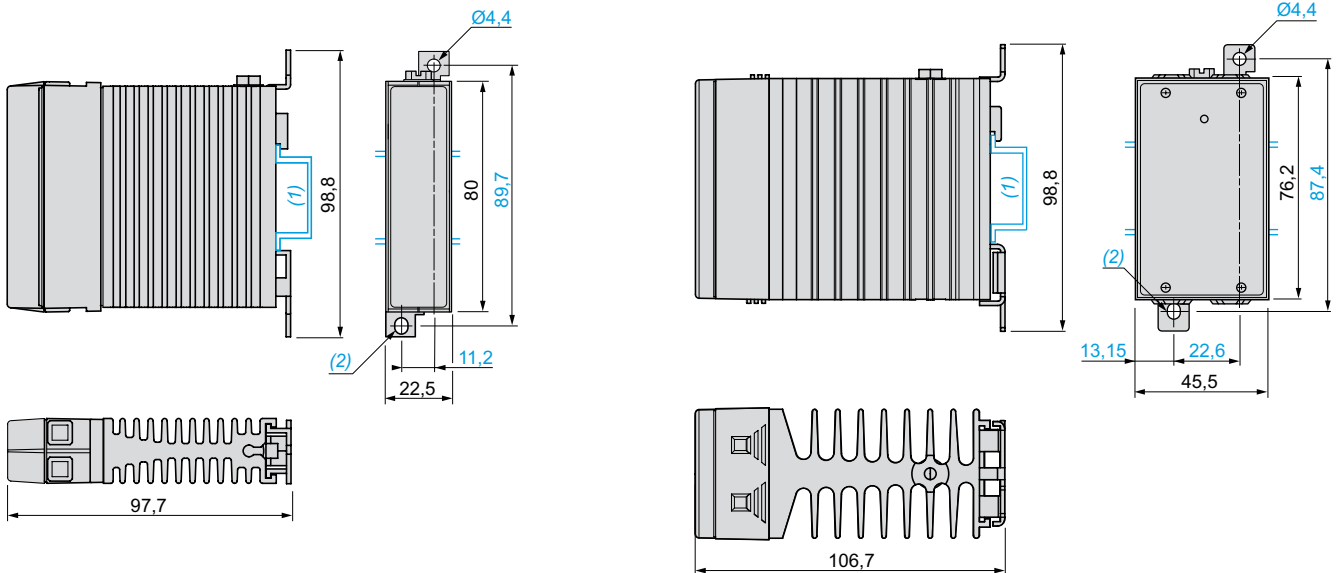

(1) 35 mm DIN rail. (2) Ø 4.4 x 5.5 elongated hole

(1) 35 mm DIN rail. (2) Ø 4.4 x 5.5 elongated hole



### Thermal derating curves

■ Panel mounting SSRP relays

□ SCR output

10 A relays

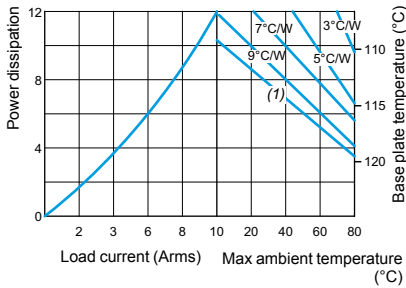

25 A relays

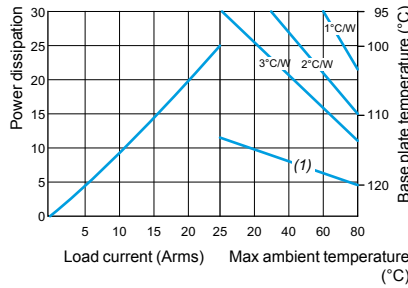

50 A relays

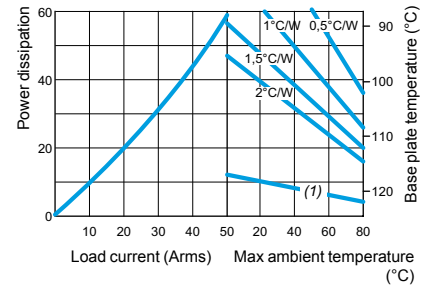

(1) No heat sink

(1) No heat sink

(1) No heat sink

75 A relays

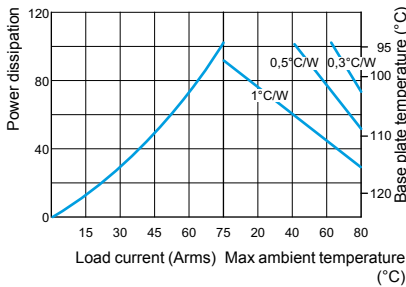

90 A relays

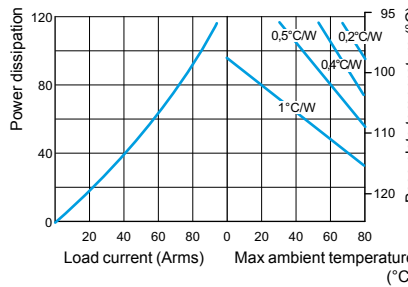

125 A relays

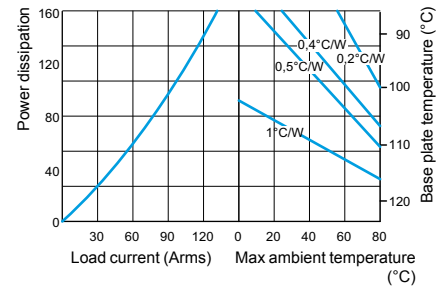

□ Mosfet output

12 A relays

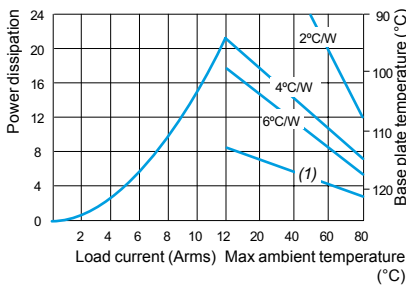

25 and 40 A relays

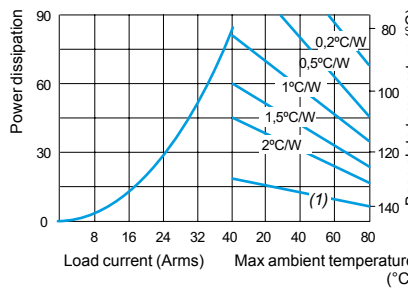

(1) No heat sink

(1) No heat sink

■ Rail mounting SSRD relays

10...45 A relays

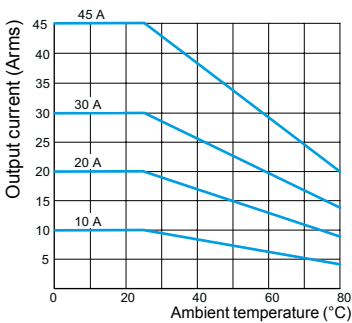

**Schneider Electric USA Inc.**

8001 Knightdale Blvd.  
Knightdale, NC 27545  
Tel: 919-266-3671

19 Waterman Avenue  
Toronto, Ontario M4B 1Y2  
Tel: 416-752-8020

<http://www.schneider-electric.us/>

The information provided in this documentation contains general descriptions and/or technical characteristics of the performance of the products contained herein. This documentation is not intended as a substitute for and is not to be used for determining suitability or reliability of these products for specific user applications. It is the duty of any such user or integrator to perform the appropriate and complete risk analysis, evaluation and testing of the products with respect to the relevant specific application or use thereof. Neither Schneider Electric nor any of its affiliates or subsidiaries shall be responsible or liable for misuse of the information contained herein.

**Please note:** not all parts listed in this catalog are available in all countries.

Design: Schneider Electric  
Photos: Schneider Electric



2010 Electromechanical and solid-state Zelio® Relays

